

Steel Sitting Height Base Cabinets

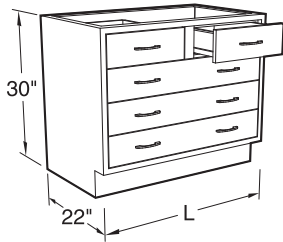

Specifications:

Sitting Height Cabinets are 30" high and 22" deep. Lengths as shown.

Open Cabinets have one adjustable shelf.

Cupboards have one adjustable shelf.

Note: Last four digits of part number designate door and drawer head style, material, and pull selection. See page 4 for full explanation. Actual product may vary slightly from catalog illustration due to style and hardware selection

* Not available in Textured Steel.

Open Cabinets*

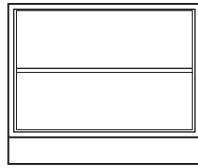
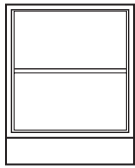

B00M312215-0000*	15"L	B00M312230-0000*	30"L
B00M312218-0000*	18"L	B00M312236-0000*	36"L
B00M312221-0000*	21"L	B00M312242-0000*	42"L
B00M312224-0000*	24"L	B00M312248-0000*	48"L

Cupboard Cabinets

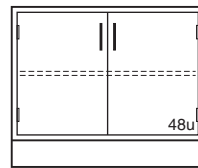
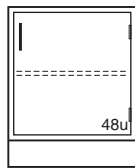
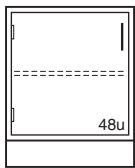

C03M312215L _____	15"L	C03M312215- _____	15"L	C03M312230- _____	30"L
C03M312218L _____	18"L	C03M312218- _____	18"L	C03M312236- _____	36"L
C03M312221L _____	21"L	C03M312221- _____	21"L	C03M312242- _____	42"L
C03M312224L _____	24"L	C03M312224- _____	24"L	C03M312248- _____	48"L

Drawer Cabinets

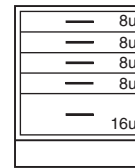
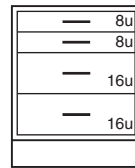
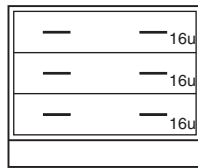
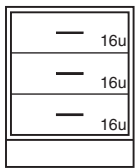

D00M312215- _____	15"L	D00M312230- _____	30"L	D08M312215- _____	15"L	D10M312215- _____	15"L
D00M312218- _____	18"L	D00M312236- _____	36"L	D08M312218- _____	18"L	D10M312218- _____	18"L
D00M312221- _____	21"L	D00M312242- _____	42"L	D08M312221- _____	21"L	D10M312221- _____	21"L
D00M312224- _____	24"L	D00M312248- _____	48"L	D08M312224- _____	24"L	D10M312224- _____	24"L

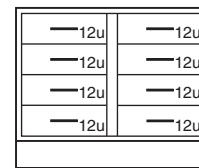
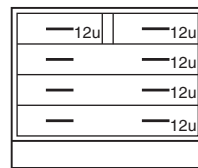
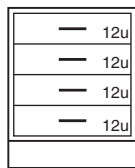
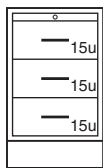

D26M312218- _____	18"L	D30M312215- _____	15"L	D31M312230- _____	30"L	D32M312230- _____	30"L
1 Pull Out Shelf		D30M312218- _____	18"L	D31M312236- _____	36"L	D32M312236- _____	36"L
		D30M312221- _____	21"L	D31M312242- _____	42"L	D32M312242- _____	42"L
		D30M312224- _____	24"L	D31M312248- _____	48"L	D32M312248- _____	48"L

Steel Sitting Height Base Cabinets

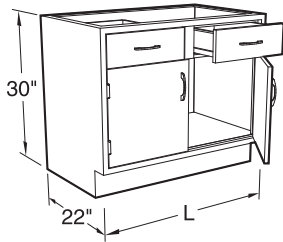

Specifications:

Sitting Height Cabinets are 30" high and 22" deep. Lengths as shown.

Note: Last four digits of part number designate door and drawer head style, material, and pull selection. See page 4 for full explanation. Actual product may vary slightly from catalog illustration due to style and hardware selection.

Drawer Cabinets

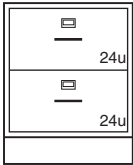

D81M312218- 18"L
D81M312221- 21"L
D81M312224- 24"L

2 File Drawer with hangers

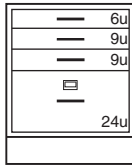

D83M312218- 18"L
D83M312221- 21"L
D83M312224- 24"L

1 File Drawer with hangers

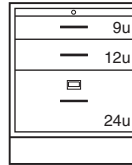

D84M312218- 18"L
D84M312221- 21"L
D84M312224- 24"L

Pull Out Shelf,
1 File Drawer with hangers

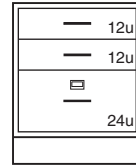

D85M312218- 18"L
D85M312221- 21"L
D85M312224- 24"L

1 File Drawer with hangers

Cupboard and Drawer Cabinets

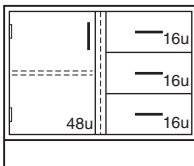

E05M312230L 30"L
E05M312236L 36"L
E05M312242L 42"L
E05M312248L 48"L

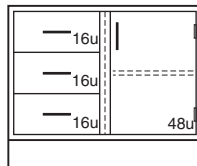

E05M312230- 30"L
E05M312236- 36"L
E05M312242- 42"L
E05M312248- 48"L

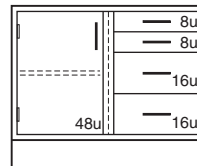

E06M312230L 30"L
E06M312236L 36"L
E06M312242L 42"L
E06M312248L 48"L

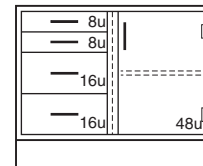

E06M312230- 30"L
E06M312236- 36"L
E06M312242- 42"L
E06M312248- 48"L

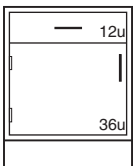

E40M312215L 15"L
E40M312218L 18"L
E40M312221L 21"L
E40M312224L 24"L

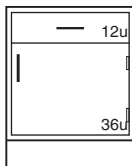

E40M312215- 15"L
E40M312218- 18"L
E40M312221- 21"L
E40M312224- 24"L

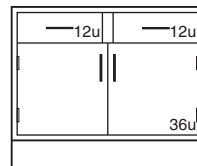

E41M312230- 30"L
E41M312236- 36"L
E41M312242- 42"L
E41M312248- 48"L

Steel Sitting Height Base Cabinets

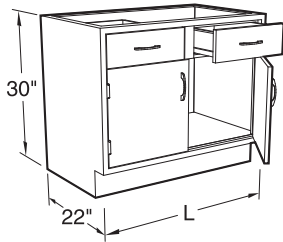

Specifications:

Sitting Height Cabinets are 30" high and 22" deep. Lengths as shown.

Sink Cabinets are provided with sink supports.

Note: Last four digits of part number designate door and drawer head style, material, and pull selection. See page 4 for full explanation. Actual product may vary slightly from catalog illustration due to style and hardware selection.

Cupboard and Drawer Cabinets

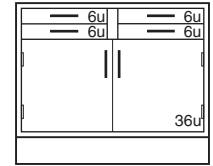
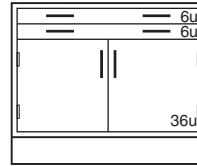
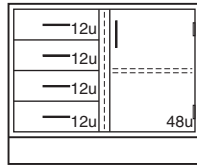
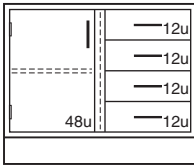

E44M312230L ----- 30"L	E44M312230- ----- 30"L	E70M312230- ----- 30"L	E71M312230- ----- 30"L
E44M312236L ----- 36"L	E44M312236- ----- 36"L	E70M312236- ----- 36"L	E71M312236- ----- 36"L
E44M312242L ----- 42"L	E44M312242- ----- 42"L	E70M312242- ----- 42"L	E71M312242- ----- 42"L
E44M312248L ----- 48"L	E44M312248- ----- 48"L	E70M312248- ----- 48"L	E71M312248- ----- 48"L

Sink Cabinets

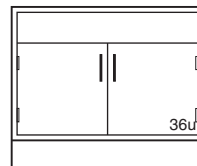
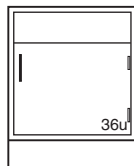
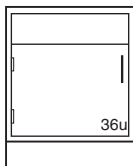

G00M312215L ----- 15"L	G00M312215- ----- 15"L	G00M312230- ----- 30"L
G00M312218L ----- 18"L	G00M312218- ----- 18"L	G00M312236- ----- 36"L
G00M312221L ----- 21"L	G00M312221- ----- 21"L	G00M312242- ----- 42"L
G00M312224L ----- 24"L	G00M312224- ----- 24"L	G00M312248- ----- 48"L

Diagonal Corner Cabinets

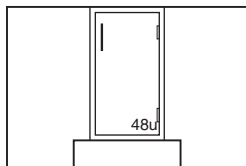

G14M312214- -----

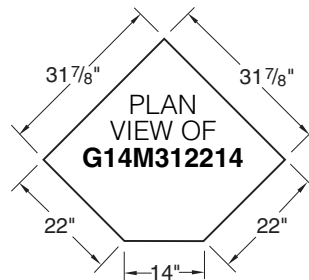

Steel ADA Height Base Cabinets

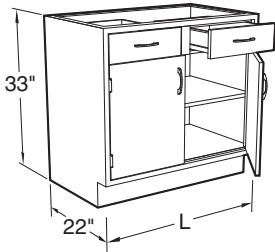

Specifications:

ADA Height Cabinets are 33" high and 22" deep. Lengths as shown.

Cupboards have one adjustable shelf.

Note: Last four digits of part number designate door and drawer head style, material, and pull selection. See page 4 for full explanation. Actual product may vary slightly from catalog illustration due to style and hardware selection.

Cupboard Cabinets

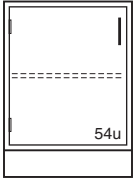

C03M342215L ----- 15"L
C03M342218L ----- 18"L
C03M342221L ----- 21"L
C03M342224L ----- 24"L

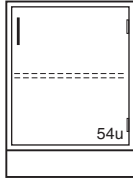

C03M342215- ----- 15"L
C03M342218- ----- 18"L
C03M342221- ----- 21"L
C03M342224- ----- 24"L

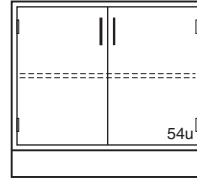

C03M342230- ----- 30"L
C03M342236- ----- 36"L
C03M342242- ----- 42"L
C03M342248- ----- 48"L

Drawer Cabinets

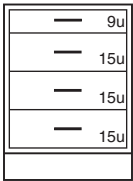

D30M342215- ----- 15"L
D30M342218- ----- 18"L
D30M342221- ----- 21"L
D30M342224- ----- 24"L

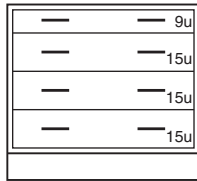

D30M342230- ----- 30"L
D30M342236- ----- 36"L
D30M342242- ----- 42"L
D30M342248- ----- 48"L

Cupboard and Drawer Cabinets

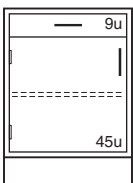

E40M342215L ----- 15"L
E40M342218L ----- 18"L
E40M342221L ----- 21"L
E40M342224L ----- 24"L

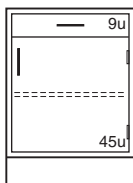

E40M342215- ----- 15"L
E40M342218- ----- 18"L
E40M342221- ----- 21"L
E40M342224- ----- 24"L

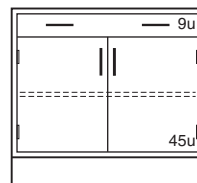

E40M342230- ----- 30"L
E40M342236- ----- 36"L
E40M342242- ----- 42"L
E40M342248- ----- 48"L

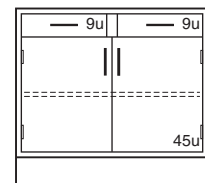

E41M342230- ----- 30"L
E41M342236- ----- 36"L
E41M342242- ----- 42"L
E41M342248- ----- 48"L

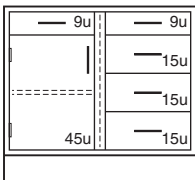

E43M342230L ----- 30"L
E43M342236L ----- 36"L
E43M342242L ----- 42"L
E43M342248L ----- 48"L

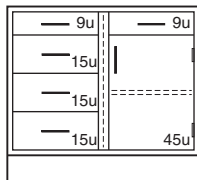

E43M342230- ----- 30"L
E43M342236- ----- 36"L
E43M342242- ----- 42"L
E43M342248- ----- 48"L

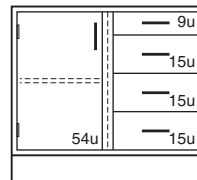

E45M342230L ----- 30"L
E45M342236L ----- 36"L
E45M342242L ----- 42"L
E45M342248L ----- 48"L

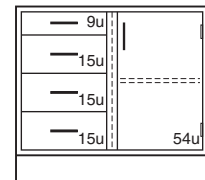

E45M342230- ----- 30"L
E45M342236- ----- 36"L
E45M342242- ----- 42"L
E45M342248- ----- 48"L

Steel ADA Height Base Cabinets

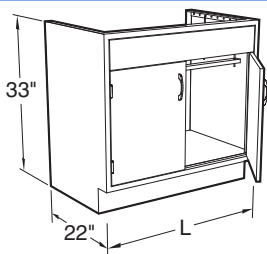

Specifications:

ADA Height Cabinets are 33" high and 22" deep. Lengths as shown.

Sink Cabinets are provided with sink supports.

Note: Last four digits of part number designate door and drawer head style, material, and pull selection. See page 4 for full explanation. Actual product may vary slightly from catalog illustration due to style and hardware selection.

Sink Cabinets

Wheelchair Accessible

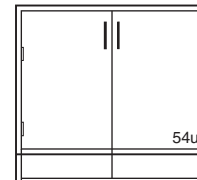
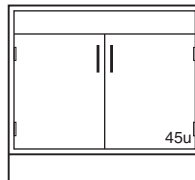
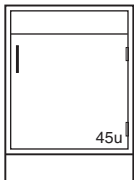
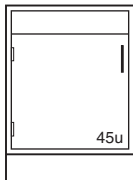

- G00M342212L _____ 12"L
- G00M342215L _____ 15"L
- G00M342218L _____ 18"L
- G00M342221L _____ 21"L
- G00M342224L _____ 24"L

- G00M342212- _____ 12"L
- G00M342215- _____ 15"L
- G00M342218- _____ 18"L
- G00M342221- _____ 21"L
- G00M342224- _____ 24"L

- G00M342230- _____ 30"L
- G00M342236- _____ 36"L
- G00M342242- _____ 42"L
- G00M342248- _____ 48"L

- G03M342236- _____ 36"L
- G03M342242- _____ 42"L
- G03M342248- _____ 48"L

Fume Hood Base Cabinets

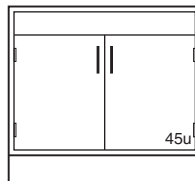
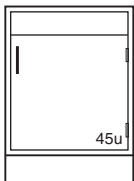
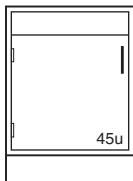

- G08M342212L _____ 12"L
- G08M342215L _____ 15"L
- G08M342218L _____ 18"L
- G08M342221L _____ 21"L
- G08M342224L _____ 24"L

- G08M342212- _____ 12"L
- G08M342215- _____ 15"L
- G08M342218- _____ 18"L
- G08M342221- _____ 21"L
- G08M342224- _____ 24"L

- G08M342230- _____ 30"L
- G08M342236- _____ 36"L
- G08M342242- _____ 42"L
- G08M342248- _____ 48"L

Acid Storage Cabinets

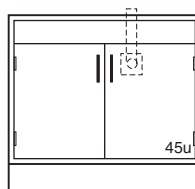
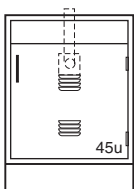
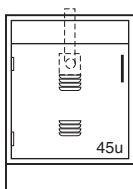

- G80M342224L _____ 24"L

- G80M342224- _____ 24"L

- G80M342230- _____ 30"L
- G80M342236- _____ 36"L
- G80M342248- _____ 48"L

Diagonal Corner Cabinet

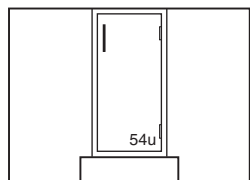

G14M342214- _____

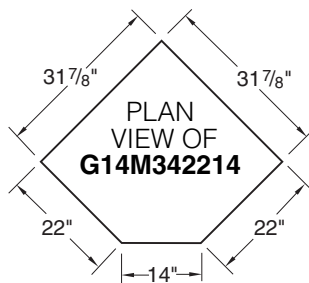

Steel Standing Height Base Cabinets

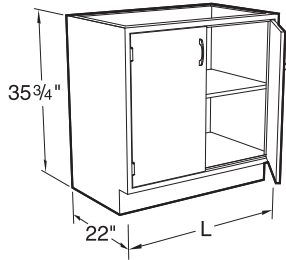

Specifications:

Standing Height Cabinets are 35³/₄" high and 22" deep. Lengths as shown.

Open Cabinets have two adjustable shelves.

Cupboards have one adjustable shelf.

Note: Last four digits of part number designate door and drawer head style, material, and pull selection. See page 4 for full explanation. Actual product may vary slightly from catalog illustration due to style and hardware selection.

* Not available in Textured Steel.

Open Cabinets*

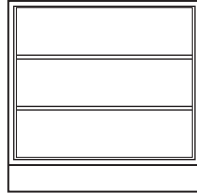
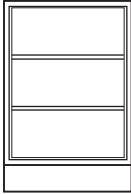

B00M372215-0000*	15"L	B00M372230-0000*	30"L
B00M372218-0000*	18"L	B00M372236-0000*	36"L
B00M372221-0000*	21"L	B00M372242-0000*	42"L
B00M372224-0000*	24"L	B00M372248-0000*	48"L

Cupboard Cabinets

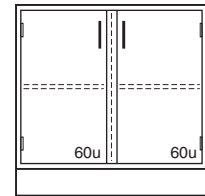
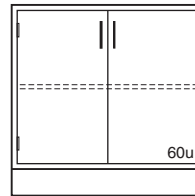
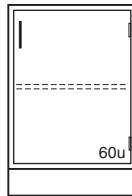
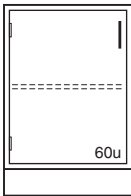

C03M372212L _____	12"L	C03M372212- _____	12"L	C03M372230- _____	30"L	C06M372236- _____	36"L
C03M372215L _____	15"L	C03M372215- _____	15"L	C03M372236- _____	36"L	C06M372248- _____	48"L
C03M372218L _____	18"L	C03M372218- _____	18"L	C03M372242- _____	42"L		
C03M372221L _____	21"L	C03M372221- _____	21"L	C03M372248- _____	48"L		
C03M372224L _____	24"L	C03M372224- _____	24"L				

Drawer Cabinets

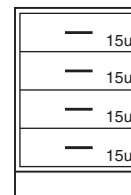
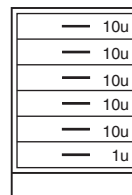
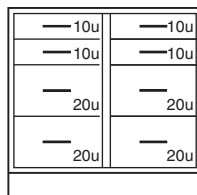
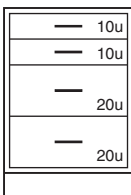

D08M372215- _____	15"L	D09M372230- _____	30"L	D20M372215- _____	15"L	D30M372212- _____	12"L
D08M372218- _____	18"L	D09M372236- _____	36"L	D20M372218- _____	18"L	D30M372215- _____	15"L
D08M372221- _____	21"L	D09M372242- _____	42"L	D20M372221- _____	21"L	D30M372218- _____	18"L
D08M372224- _____	24"L	D09M372248- _____	48"L	D20M372224- _____	24"L	D30M372221- _____	21"L
						D30M372224- _____	24"L

Steel Standing Height Base Cabinets

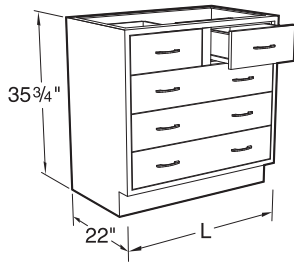

Specifications:

Standing Height Cabinets are 35³/₄" high and 22" deep. Lengths as shown.

Note: Last four digits of part number designate door and drawer head style, material, and pull selection. See page 4 for full explanation. Actual product may vary slightly from catalog illustration due to style and hardware selection.

Drawer Cabinets

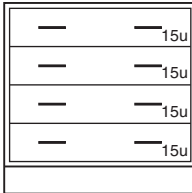

D30M372230- 30"L
D30M372236- 36"L
D30M372242- 42"L
D30M372248- 48"L

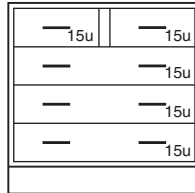

D31M372230- 30"L
D31M372236- 36"L
D31M372242- 42"L
D31M372248- 48"L

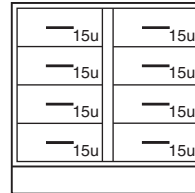

D32M372230- 30"L
D32M372236- 36"L
D32M372242- 42"L
D32M372248- 48"L

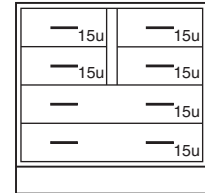

D36M372230- 30"L
D36M372236- 36"L
D36M372242- 42"L
D36M372248- 48"L

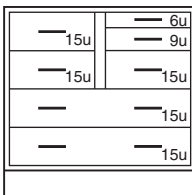

D37M372230- 30"L
D37M372236- 36"L
D37M372242- 42"L
D37M372248- 48"L

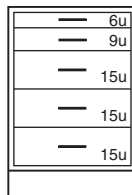

D38M372215- 15"L
D38M372218- 18"L
D38M372221- 21"L
D38M372224- 24"L

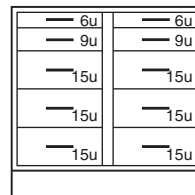

D39M372230- 30"L
D39M372236- 36"L
D39M372242- 42"L
D39M372248- 48"L

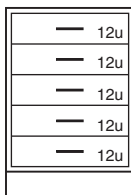

D50M372215- 15"L
D50M372218- 18"L
D50M372221- 21"L
D50M372224- 24"L

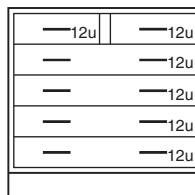

D51M372230- 30"L
D51M372236- 36"L
D51M372242- 42"L
D51M372248- 48"L

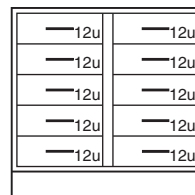

D52M372230- 30"L
D52M372236- 36"L
D52M372242- 42"L
D52M372248- 48"L

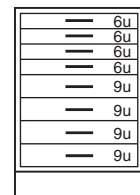

D62M372218- 18"L
D62M372224- 24"L

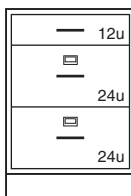

D81M372218- 18"L
D81M372221- 21"L
D81M372224- 24"L

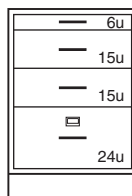

D83M372215- 15"L
D83M372218- 18"L
D83M372224- 24"L

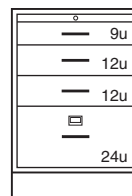

D84M372218- 18"L
D84M372221- 21"L
D84M372224- 24"L

2 File Drawers with hangers

1 File Drawer with hangers

Pull Out Shelf
 1 File Drawer with hangers

Steel Standing Height Base Cabinets

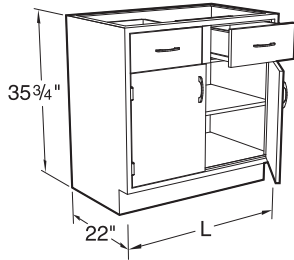

Specifications:

Standing Height Cabinets are 35³/₄" high and 22" deep. Lengths as shown. Cupboards have one adjustable shelf.

Note: Last four digits of part number designate door and drawer head style, material, and pull selection. See page 4 for full explanation. Actual product may vary slightly from catalog illustration due to style and hardware selection.

Cupboard and Drawer Cabinets

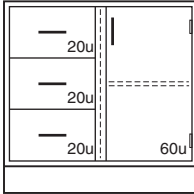

- E05M372230- 30"L
- E05M372236- 36"L
- E05M372242- 42"L
- E05M372248- 48"L

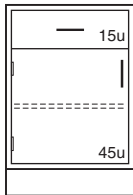

- E40M372212L 12"L
- E40M372215L 15"L
- E40M372218L 18"L
- E40M372221L 21"L
- E40M372224L 24"L

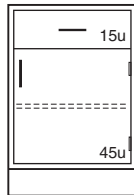

- E40M372212- 12"L
- E40M372215- 15"L
- E40M372218- 18"L
- E40M372221- 21"L
- E40M372224- 24"L

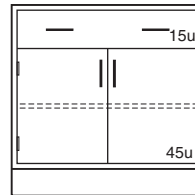

- E40M372230- 30"L
- E40M372236- 36"L
- E40M372242- 42"L
- E40M372248- 48"L

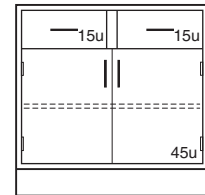

- E41M372230- 30"L
- E41M372236- 36"L
- E41M372242- 42"L
- E41M372248- 48"L

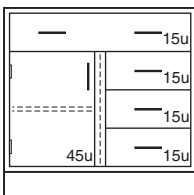

- E42M372230L 30"L
- E42M372236L 36"L
- E42M372242L 42"L
- E42M372248L 48"L

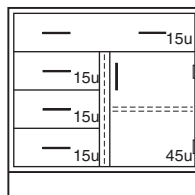

- E42M372230- 30"L
- E42M372236- 36"L
- E42M372242- 42"L
- E42M372248- 48"L

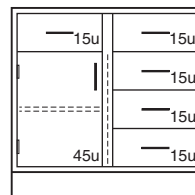

- E43M372230L 30"L
- E43M372236L 36"L
- E43M372242L 42"L
- E43M372248L 48"L

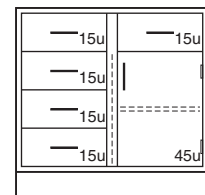

- E43M372230- 30"L
- E43M372236- 36"L
- E43M372242- 42"L
- E43M372248- 48"L

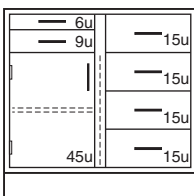

- E44M372230L 30"L
- E44M372236L 36"L
- E44M372242L 42"L
- E44M372248L 48"L

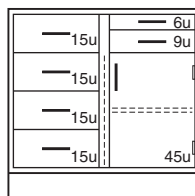

- E44M372230- 30"L
- E44M372236- 36"L
- E44M372242- 42"L
- E44M372248- 48"L

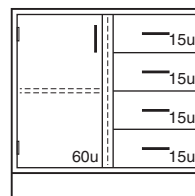

- E45M372230L 30"L
- E45M372236L 36"L
- E45M372242L 42"L
- E45M372248L 48"L

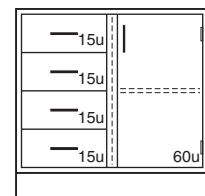

- E45M372230- 30"L
- E45M372236- 36"L
- E45M372242- 42"L
- E45M372248- 48"L

Steel Standing Height Base Cabinets

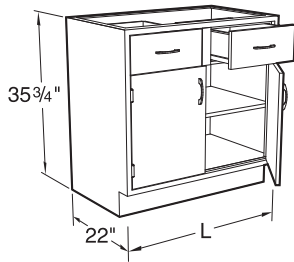

Specifications:

Standing Height Cabinets are 35³/₄" high and 22" deep. Lengths as shown. Cupboards have one adjustable shelf.

Note: Last four digits of part number designate door and drawer head style, material, and pull selection. See page 4 for full explanation. Actual product may vary slightly from catalog illustration due to style and hardware selection.

Cupboard and Drawer Cabinets

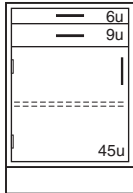

E50M372215L ----- 15"L
E50M372218L ----- 18"L
E50M372221L ----- 21"L
E50M372224L ----- 24"L

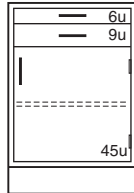

E50M372215- ----- 15"L
E50M372218- ----- 18"L
E50M372221- ----- 21"L
E50M372224- ----- 24"L

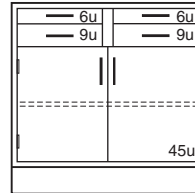

E51M372230- ----- 30"L
E51M372236- ----- 36"L
E51M372242- ----- 42"L
E51M372248- ----- 48"L

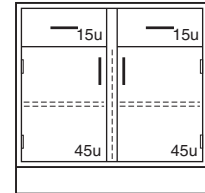

E56M372236- ----- 36"L
E56M372248- ----- 48"L

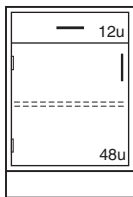

E60M372218L ----- 18"L
E60M372224L ----- 24"L

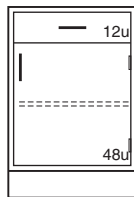

E60M372218- ----- 18"L
E60M372224- ----- 24"L

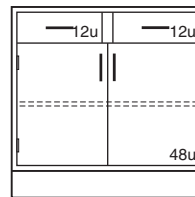

E61M372236- ----- 36"L
E61M372248- ----- 48"L

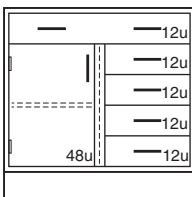

E62M372230L ----- 30"L
E62M372236L ----- 36"L
E62M372242L ----- 42"L
E62M372248L ----- 48"L

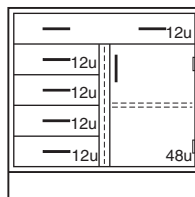

E62M372230- ----- 30"L
E62M372236- ----- 36"L
E62M372242- ----- 42"L
E62M372248- ----- 48"L

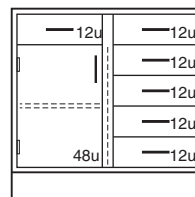

E63M372230L ----- 30"L
E63M372236L ----- 36"L
E63M372242L ----- 42"L
E63M372248L ----- 48"L

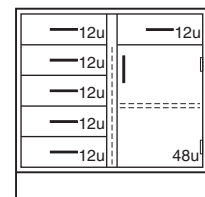

E63M372230- ----- 30"L
E63M372236- ----- 36"L
E63M372242- ----- 42"L
E63M372248- ----- 48"L

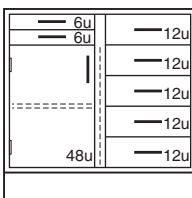

E64M372230L ----- 30"L
E64M372236L ----- 36"L
E64M372242L ----- 42"L
E64M372248L ----- 48"L

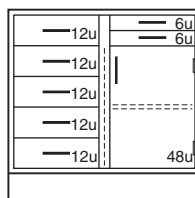

E64M372230- ----- 30"L
E64M372236- ----- 36"L
E64M372242- ----- 42"L
E64M372248- ----- 48"L

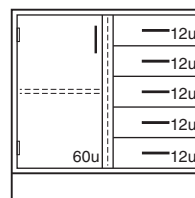

E65M372230L ----- 30"L
E65M372236L ----- 36"L
E65M372242L ----- 42"L
E65M372248L ----- 48"L

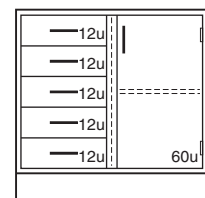

E65M372230- ----- 30"L
E65M372236- ----- 36"L
E65M372242- ----- 42"L
E65M372248- ----- 48"L

Steel Standing Height Base Cabinets

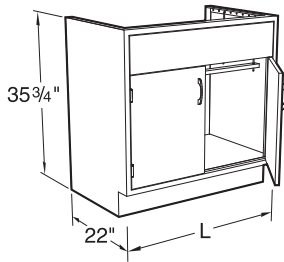

Specifications:

Standing Height Cabinets are 35³/₄" high and 22" deep. Lengths as shown. Sink Cabinets are provided with sink supports.

Note: Last four digits of part number designate door and drawer head style, material, and pull selection. See page 4 for full explanation. Actual product may vary slightly from catalog illustration due to style and hardware selection.

Sink Cabinets

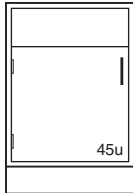

- G00M372212L _____ 12"L
- G00M372215L _____ 15"L
- G00M372218L _____ 18"L
- G00M372221L _____ 21"L
- G00M372224L _____ 24"L

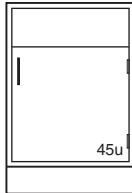

- G00M372212- _____ 12"L
- G00M372215- _____ 15"L
- G00M372218- _____ 18"L
- G00M372221- _____ 21"L
- G00M372224- _____ 24"L

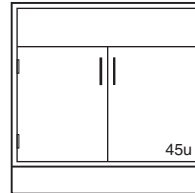

- G00M372230- _____ 30"L
- G00M372236- _____ 36"L
- G00M372242- _____ 42"L
- G00M372248- _____ 48"L

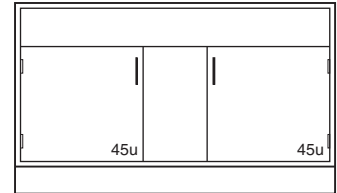

- G00M372260- _____ 60"L

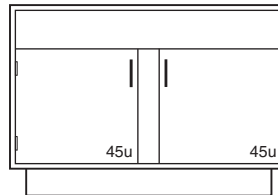

- G04M372252- _____ 52"L
- G04M372258- _____ 58"L
- G04M372260- _____ 60"L

Center Bench End Sink Cabinet

G04... Cabinets are furnished with finished back panels that may be removed when not required. Finished back adds 1" to depth, making overall cabinet depth 23".

Acid Storage Cabinet

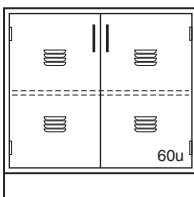

- G21M372230- _____ 30"L
- G21M372236- _____ 36"L
- G21M372248- _____ 48"L

Acid Storage Cabinets are manufactured with corrosion resistant polyethylene lining. Furnished with louvered doors and half-depth removable shelf.

Drying Cabinet

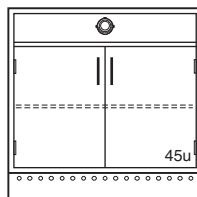

- G31M372236- _____ 36"L
- G31M372248- _____ 48"L

Electrically Heated Drying Cabinets are insulated to prevent heat loss. Each is furnished with one adjustable wire mesh shelf and a wire mesh bottom. Cabinets are heated with single phase 240 volt AC strip heaters. (Single phase, 120 volt AC heaters are also available when specified.) A thermostat control for the heaters is included. Maximum operating temperature is 140°F. Power consumption is 1500 watts for the 36" cabinet and 2000 watts for the 48" cabinet. **Internal wiring is not included.**

Waste Storage Cabinet

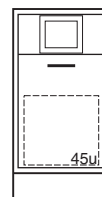

- G20M372215- _____ 15"L
- G20M372218- _____ 18"L

Cabinet furnished with 13" deep, cold rolled steel bin, mounted on full extension drawer slides for ease of access. Includes 6" x 5" (opening) stainless steel waste chute

Tilting Bin Cabinet



- G41M372218- _____ 18"L

Bin is mounted on pivots that counterbalance bin when loaded.

Steel Standing Height Base Cabinets

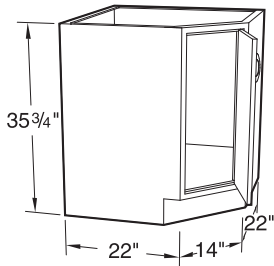

Specifications:

Standing Height Cabinets are 35³/₄" high and 22" deep. Lengths as shown.

Blind Corner Cabinets have one adjustable shelf.

Note: Last four digits of part number designate door and drawer head style, material, and pull selection. See page 4 for full explanation. Actual product may vary slightly from catalog illustration due to style and hardware selection.

Blind Corner Cabinets

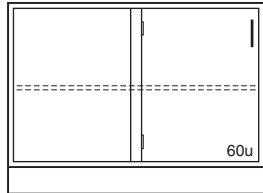

G12M372248-_____ 48"L

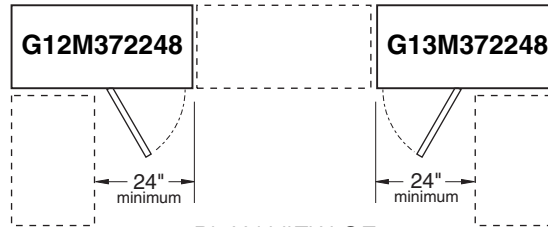

PLAN VIEW OF
G12M372248- & G13M372248-

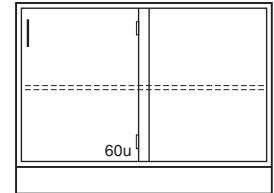

G13M372248-_____ 48"L

Diagonal Corner Cabinets

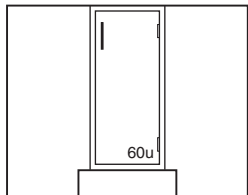

G14M372214-_____

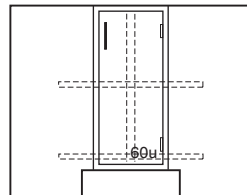

G15M372214-_____

Provided with Lazy Susan

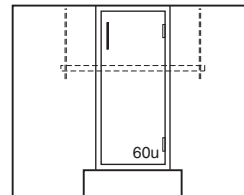

G16M372214-_____

Provided with Sink Supports

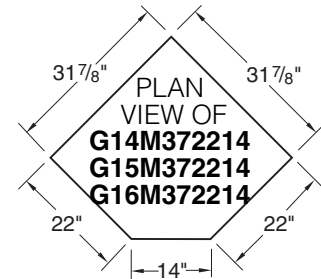

Steel Standing Height Base Cabinets

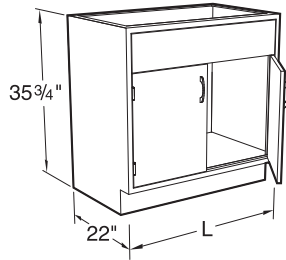

Specifications:

Standing Height Cabinets are 35³/₄" high and 22" deep. Lengths as shown.

Note: Last four digits of part number designate door and drawer head style, material, and pull selection. See page 4 for full explanation. Actual product may vary slightly from catalog illustration due to style and hardware selection.

Fume Hood Cabinets

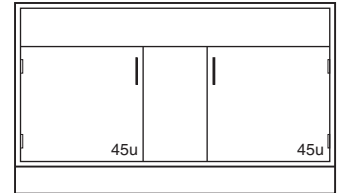
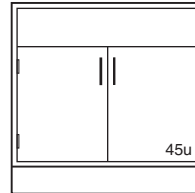
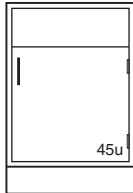
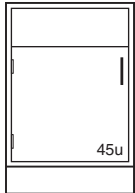

G08M372212L _____ 12"L	G08M372212- _____ 12"L	G08M372230- _____ 30"L	G08M372260- _____ 60"L
G08M372215L _____ 15"L	G08M372215- _____ 15"L	G08M372236- _____ 36"L	
G08M372218L _____ 18"L	G08M372218- _____ 18"L	G08M372242- _____ 42"L	
G08M372221L _____ 21"L	G08M372221- _____ 21"L	G08M372248- _____ 48"L	
G08M372224L _____ 24"L	G08M372224- _____ 24"L		

Acid Storage Fume Hood Cabinets

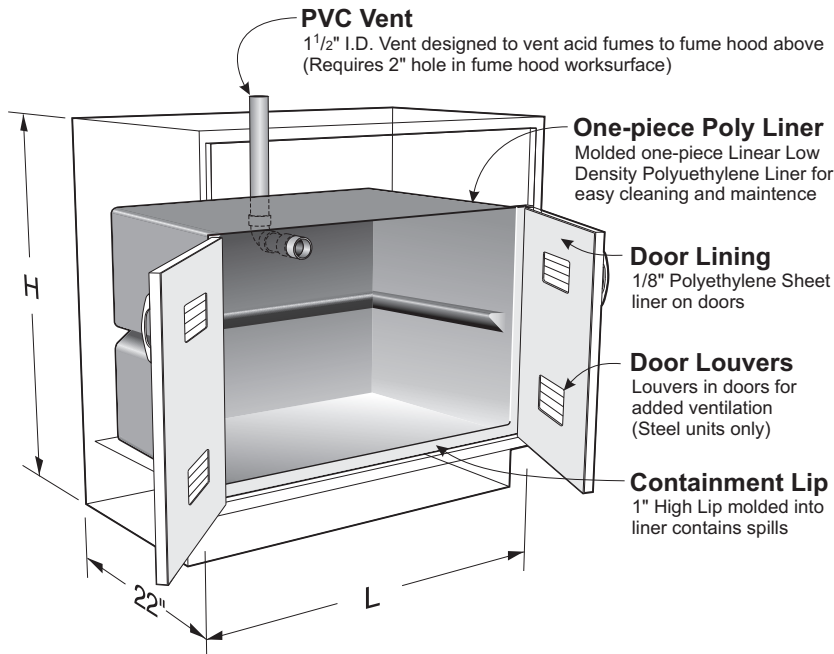

Acid Storage Fume Hood Cabinets are manufactured with a one-piece polyethylene corrosion resistant lining, lipped at the bottom to retain spills. Each cabinet is furnished with a PVC vent designed to vent to a fume hood above. (Requires fume hood work top with vent hole.) Lining is molded with cleat to accept an optional half-depth, removable, shelf is available separately.

Optional Removable Shelf

019624	Shelf for 24" cabinet
019625	Shelf for 30" cabinet
019626	Shelf for 36" cabinet
019627	Shelf for 48" cabinet

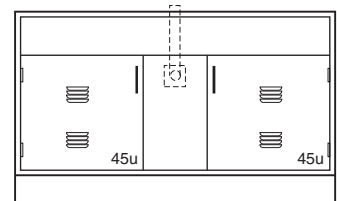
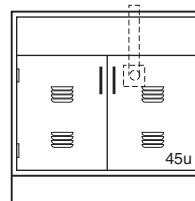
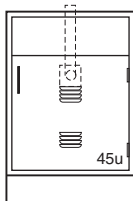
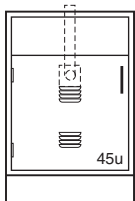

G80M372224L _____ 24"L	G80M372224- _____ 24"L	G80M372230- _____ 30"L	G80M372260- _____ 60"L
		G80M372236- _____ 36"L	
		G80M372248- _____ 48"L	

Steel Standing Height Base Cabinets

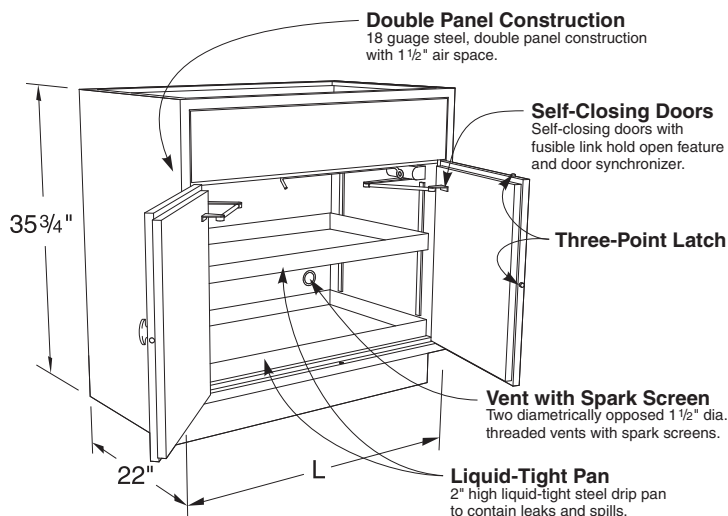

Specifications:

Steel Solvent Storage Base Cabinets are 35 3/4" high and 22" deep. Lengths as shown. Solvent Storage Cabinets are specifically designed for the storage of flammable and combustible liquids. Construction meets the requirements listed by UFC, OSHA and NFPA No. 30-2008 and are UL listed under UL standard 1275. The cabinet is all 18 gauge steel double panel construction. The doors are self-closing and synchronized so that both doors will always fully close. The right hand door is equipped with a three-point latching system that automatically engages when the doors close. Each door is equipped with a fusible-link hold-open feature that ensures the door closes should the temperature outside the cabinet exceed 165° F. A 2" deep liquid-tight sump covers the entire bottom of the cabinet to contain liquid leaks and spills. A second 2" deep liquid-tight pan is furnished as an adjustable height shelf. Two diametrically opposed vents with spark screens are provided in the back of the cabinet as well as a grounding screw. The cabinet is labeled: CAUTION – FLAMMABLE – KEEP FIRE AWAY.

Available in Style 1 only.

* Not Available in Textured Steel.

Solvent Storage Fume Hood Cabinets*

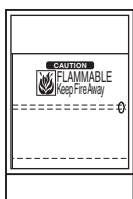

G68M3724L0100*

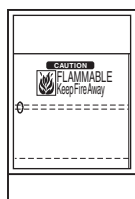

24"L G68M3724-0100*

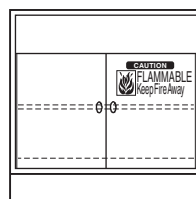

24"L G68M3730-0100* 30"L
G68M3736-0100* 36"L
G68M3748-0100* 48"L

Solvent Storage Cabinets*

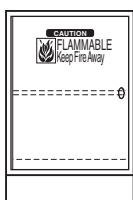

G63M3724L0100*

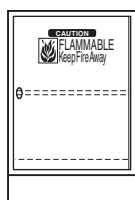

24"L G63M3724-0100*

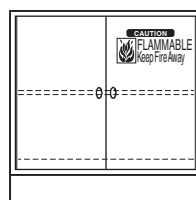

24"L G63M3730-0100* 30"L
G63M3736-0100* 36"L
G63M3748-0100* 48"L

Specifications:

Vacuum Pump Storage Fume Hood Cabinets are designed without a bottom to allow vacuum pumps and other equipment to be rolled in or out of the cabinets. The interior is lined with 1" thick neoprene foam for sound deadening and easy cleaning. Each cabinet is furnished with a 120 VAC, 20 amp, duplex receptacle for mounting on the inside cabinet back and a pilot lighted toggle switch for mounting in the top front rail. (Wiring is not included.) Cabinets are also furnished with a 2" diameter PVC vent pipe for venting or access to the hood above. (Requires a 2" hole in the hood worksurface.) The toespace rail is attached to the door to allow total access to the cabinet. Cabinet inside clearance at the floor is 16 1/2" front-to-back and 3" less than the overall cabinet length.

Vacuum Pump Storage Fume Hood Cabinets

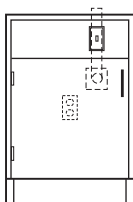

G35M372224L

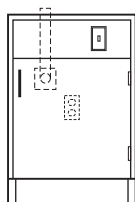

24"L G35M372224-

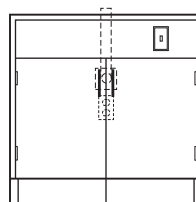

24"L G35M372230- 30"L
G35M372236- 36"L
G35M372248- 48"L