

Center Bench Shelving Assemblies

Specifications:

Shelving Support Assemblies are designed to add shelving to center benches. Each assembly consists of four uprights with slots on 1" centers and a top frame. They are 12" deep in lengths as shown.

Each assembly is furnished with mounting brackets for attaching to the counter top and cabinets below but no

fasteners. Fasteners must be furnished in field depending on top material and cabinet configuration.

Shelving Assembly Support Struts are especially designed to provide added support to the Shelving Support Assemblies while allowing space for connection of plumbing or electrical connections.

12" Deep Shelving Support Assembly

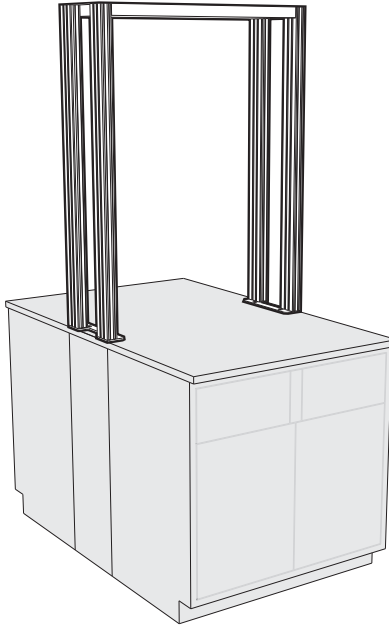

Length	Part Number
24"	F17-4824-00
30"	F17-4830-00
36"	F17-4836-00
42"	F17-4842-00
48"	F17-4848-00
54"	F17-4854-00
60"	F17-4860-00
66"	F17-4866-00
72"	F17-4872-00

Shelving Assembly Support Strut



Width	Part Number
12"	K17-3612-00
14"	K17-3614-00

Under Cabinet Light Fixtures

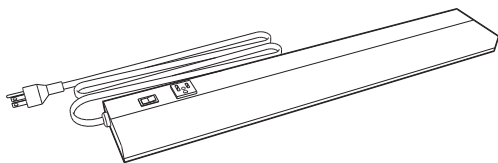

Nominal Length	Actual Length	Light Fixture	Fit Under
24"	21 ¹ / ₄ "	F-5314-00	30" & 36" shelves
36"	34 ³ / ₈ "	F-5316-00	42" & 48" shelves
48"	46 ¹ / ₈ "	F-5317-00	54" & 60" shelves

Thin-profile, specification grade, with white, painted steel housing, 1" high by 3¹/₂" deep in lengths shown. UL listed and furnished with rocker switch, single outlet, lamp, and six foot cord.

Shelf Retaining Lips

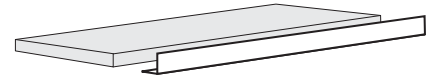

Length	Shelf Lip	
24"	F63M0224-00	each
30"	F63M0230-00	each
36"	F63M0236-00	each
42"	F63M0242-00	each
48"	F63M0248-00	each
54"	F63M0254-00	each
60"	F63M0260-00	each
66"	F63M0266-00	each
72"	F63M0272-00	each

Designed to be added to Pass-thru and Wall Shelf Assemblies. Steel Shelf Lips may be mounted to steel, wood or phenolic resin shelves with supplied screws.

Center Bench Shelving Assemblies

Specifications:

Pass-Thru Shelf Assemblies for 12" Island Modules are six inches deeper than the Shelf Bracket to allow the Shelf to pass through the module core and form a continuous surface. These shelves may also be moved forward and mounted to form a 2" cord gap between the shelves. Shelf Brackets are 11 gauge steel, adjustable on 1" centers.

Painted Steel Shelves – 1" thick, formed from 16 gauge cold rolled steel.

Oak & Maple Shelves – 1" thick hardwood plywood with matching veneer on all exposed surfaces.

Phenolic Resin – 1" thick phenolic resin.

Pass-Thru Shelf Assemblies

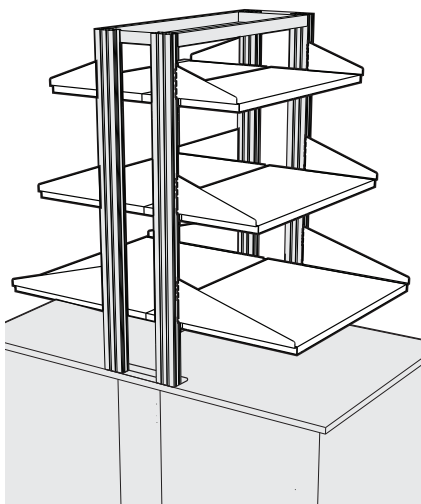

Pass-Thru Shelves

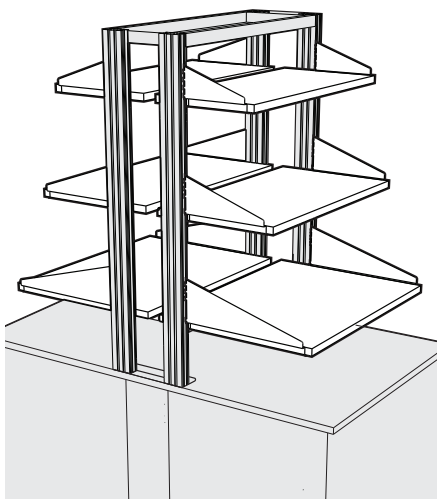

Pass-Thru Shelves with Cord Gap

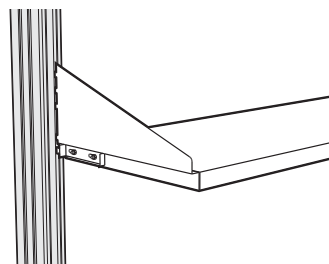

Optional Shelf Locking Tab

Length	Painted Steel	Oak Veneer	Maple Veneer	Phenolic Resin
15" DEEP SHELF 9" Deep Bracket	24" F21M0924-60	F21W0924-61	F21W0924-62	F21T0924-60
	30" F21M0930-60	F21W0930-61	F21W0930-62	F21T0930-60
	36" F21M0936-60	F21W0936-61	F21W0936-62	F21T0936-60
	42" F21M0942-60	F21W0942-61	F21W0942-62	F21T0942-60
	48" F21M0948-60	F21W0948-61	F21W0948-62	F21T0948-60
	54" F21M0954-60			
	60" F21M0960-60			
	66" F21M0966-60			
72" F21M0972-60				
18" DEEP SHELF 12" Deep Bracket	24" F21M1224-60	F21W1224-61	F21W1224-62	F21T1224-60
	30" F21M1230-60	F21W1230-61	F21W1230-62	F21T1230-60
	36" F21M1236-60	F21W1236-61	F21W1236-62	F21T1236-60
	42" F21M1242-60	F21W1242-61	F21W1242-62	F21T1242-60
	48" F21M1248-60	F21W1248-61	F21W1248-62	F21T1248-60
	54" F21M1254-60			
	60" F21M1260-60			
	66" F21M1266-60			
72" F21M1272-60				
24" DEEP SHELF 18" Deep Bracket	24" F21M1824-60	F21W1824-61	F21W1824-62	F21T1824-60
	30" F21M1830-60	F21W1830-61	F21W1830-62	F21T1830-60
	36" F21M1836-60	F21W1836-61	F21W1836-62	F21T1836-60
	42" F21M1842-60	F21W1842-61	F21W1842-62	F21T1842-60
	48" F21M1848-60	F21W1848-61	F21W1848-62	F21T1848-60
	54" F21M1854-60			
	60" F21M1860-60			

See Kewaunee's Alpha System catalog for more shelving options

Optional Shelf Locking Tab

Sliding tab mounted on Shelf Bracket locks Shelf into upright to keep it from being accidentally removed.

To specify, add an **K** to the end of the Shelf Assembly part number.

Example: **F21M1236-00K**

Wall Shelving Assemblies

Specifications:

Vertical Uprights are 1 1/4" deep and either 79" or 42" high. They are manufactured with a double-slotted face with slots on 1" centers. They are designed to be mounted between two Support Rails to hold accurate spacing.

Support Rails are available in 8 foot lengths and may be cut to the required length. Support Rails are notched on 6" centers to accept the Vertical Uprights.

Support Rail Covers are required to finish the assembly and must be ordered in pairs to match the Vertical Upright spacing.

Optional Center Rails may be ordered to provide a horizontal member at counter top height. They should be sized to match the Vertical Upright spacing.

Full Height Wall Suspension System

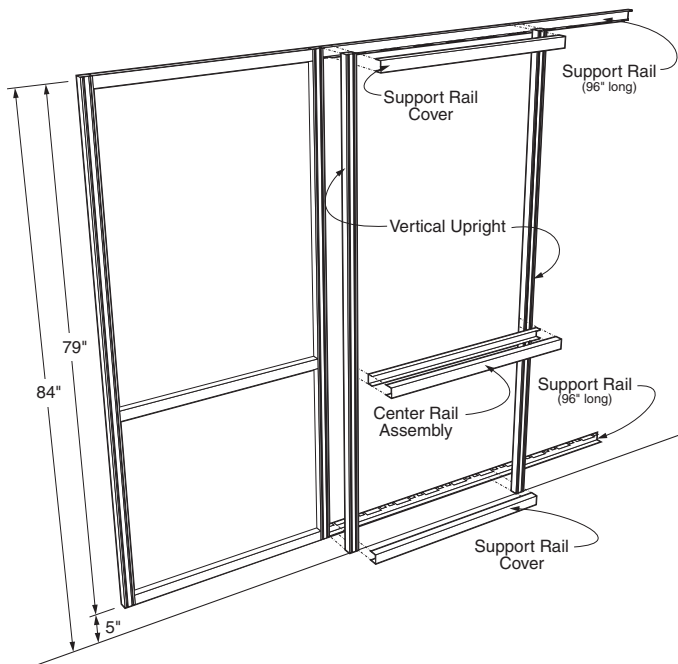

Vertical Upright

F10M0279-00 79"H pair

Support Rail

F11M0196-00 96"L each

Support Rail Covers

F11M0324-00 24"L pair

F11M0330-00 30"L pair

F11M0336-00 36"L pair

F11M0342-00 42"L pair

F11M0348-00 48"L pair

F11M0354-00 54"L pair

F11M0360-00 60"L pair

F11M0366-00 66"L pair

F11M0372-00 72"L pair

Optional Center Rail Assembly

F11M0224-00 24"L each

F11M0230-00 30"L each

F11M0236-00 36"L each

F11M0242-00 42"L each

F11M0248-00 48"L each

F11M0254-00 54"L each

F11M0260-00 60"L each

F11M0266-00 66"L each

F11M0272-00 72"L each

Above Countertop Wall Suspension System

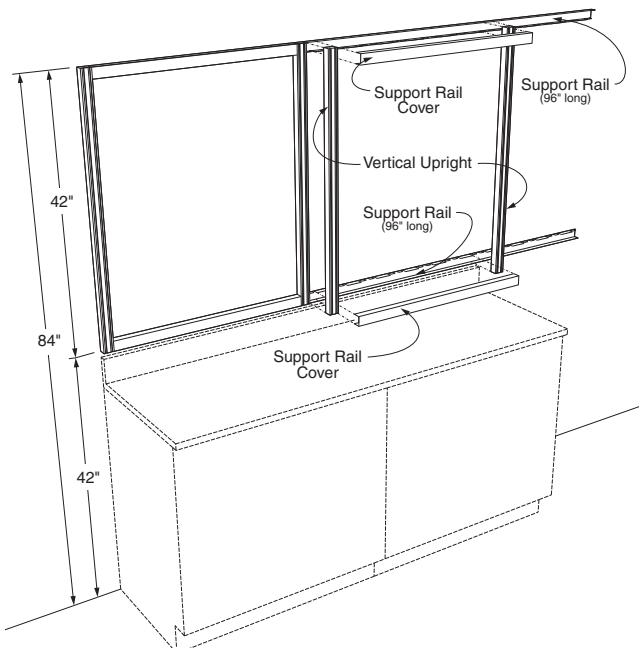

Vertical Upright

F10M0242-00 42"H pair

Support Rail

F11M0196-00 96"L each

Support Rail Covers

F11M0324-00 24"L pair

F11M0330-00 30"L pair

F11M0336-00 36"L pair

F11M0342-00 42"L pair

F11M0348-00 48"L pair

F11M0354-00 54"L pair

F11M0360-00 60"L pair

F11M0366-00 66"L pair

F11M0372-00 72"L pair

Wall Shelving Assemblies

Specifications:

Adjustable Wall Shelf Assemblies consist of a pair of 11 gauge steel Shelf Brackets and a Shelf. The Shelf Bracket engages the inner slot of the double slotted Wall Vertical Upright and is adjustable on 1" centers. Shelves are available in Painted Steel, Oak or Maple veneer plywood, or Phenolic Resin.

Painted Steel Shelves – 1" thick, formed from 16 gauge cold rolled steel.

Oak & Maple Shelves – 1" thick hardwood plywood with matching veneer on all exposed surfaces.

Phenolic Resin – 1" thick phenolic resin.

Adjustable Wall Shelf Assemblies

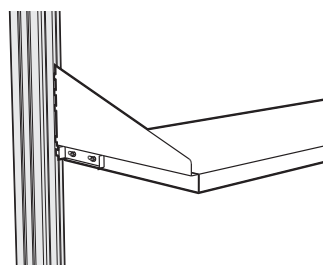
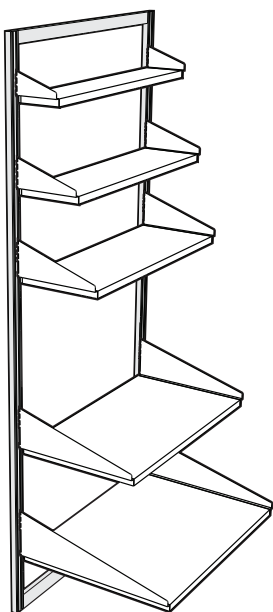

Optional Shelf Locking Tab

Sliding tab mounted on Shelf Bracket locks Shelf into upright to keep it from being accidentally removed.

To specify, add an **K** to the end of the Shelf Assembly part number.

Example: **F21M1236-00K**

	Length	Painted Steel	Oak Veneer	Maple Veneer	Phenolic Resin
6" DEEP SHELF 6" Deep Bracket	24"	F21M0624-00	F21W0624-01	F21W0624-02	F21T0624-00
	30"	F21M0630-00	F21W0630-01	F21W0630-02	F21T0630-00
	36"	F21M0636-00	F21W0636-01	F21W0636-02	F21T0636-00
	42"	F21M0642-00	F21W0642-01	F21W0642-02	F21T0642-00
	48"	F21M0648-00	F21W0648-01	F21W0648-02	F21T0648-00
	54"	F21M0654-00			
	60"	F21M0660-00			
	66"	F21M0666-00			
9" DEEP SHELF 9" Deep Bracket	72"	F21M0672-00			
	24"	F21M0924-00	F21W0924-01	F21W0924-02	F21T0924-00
	30"	F21M0930-00	F21W0930-01	F21W0930-02	F21T0930-00
	36"	F21M0936-00	F21W0936-01	F21W0936-02	F21T0936-00
	42"	F21M0942-00	F21W0942-01	F21W0942-02	F21T0942-00
	48"	F21M0948-00	F21W0948-01	F21W0948-02	F21T0948-00
	54"	F21M0954-00			
	60"	F21M0960-00			
12" DEEP SHELF 12" Deep Bracket	66"	F21M0966-00			
	72"	F21M0972-00			
	24"	F21M1224-00	F21W1224-01	F21W1224-02	F21T1224-00
	30"	F21M1230-00	F21W1230-01	F21W1230-02	F21T1230-00
	36"	F21M1236-00	F21W1236-01	F21W1236-02	F21T1236-00
	42"	F21M1242-00	F21W1242-01	F21W1242-02	F21T1242-00
	48"	F21M1248-00	F21W1248-01	F21W1248-02	F21T1248-00
	54"	F21M1254-00			
18" DEEP SHELF 18" Deep Bracket	60"	F21M1260-00			
	66"	F21M1266-00			
	72"	F21M1272-00			
	24"	F21M1824-00	F21W1824-01	F21W1824-02	F21T1824-00
	30"	F21M1830-00	F21W1830-01	F21W1830-02	F21T1830-00
	36"	F21M1836-00	F21W1836-01	F21W1836-02	F21T1836-00
	42"	F21M1842-00	F21W1842-01	F21W1842-02	F21T1842-00
	48"	F21M1848-00	F21W1848-01	F21W1848-02	F21T1848-00
24" DEEP SHELF 24" Deep Bracket	54"	F21M1854-00			
	60"	F21M1860-00			
	24"	F21M2424-00	F21W2424-01	F21W2424-02	F21T2424-00
	30"	F21M2430-00	F21W2430-01	F21W2430-02	F21T2430-00
	36"	F21M2436-00	F21W2436-01	F21W2436-02	F21T2436-00
	42"	F21M2442-00	F21W2442-01	F21W2442-02	F21T2442-00
	48"	F21M2448-00	F21W2448-01	F21W2448-02	F21T2448-00
	54"	F21M2454-00			
60"	F21M2460-00				

See Kewaunee's Alpha System catalog for more shelving options

Reagent Racks & Shelving Systems

Fabricated from cold-rolled steel, Reagent Rack Uprights and steel Facias are painted with Kewaunee's unique acid resistant finish to match or complement the casework color. Uprights include all installation hardware. Spacing between upright should not exceed 48" unless facias are used.

All uprights are designed to support the top ledge. (Note: It is recommended that the PL-4812-00 ledge be used with the W-0001-1A and/or W-0005-1A uprights.) The W-0201-0A upright, 24 1/2" high, has holes on 2" centers to provide additional storage on an intermediate shelf.

Reagent Rack Ledges, Intermediate Shelves and Facia Panels are black plastic laminate on a 45# particle board core, self-edged on four sides and a backer sheet on the bottom.

Typical Reagent Rack Assemblies

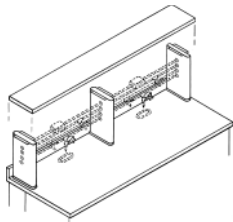

Wall bench open type reagent rack with ledge raised. Service piping, electrical conduit and fittings are dotted to show use of No. W-0001-1A uprights.

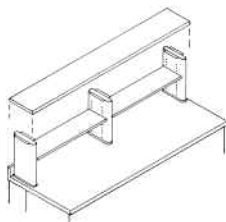

W-0201-0A uprights are 24 1/2" high and accommodate an intermediate shelf. Plug buttons come with upright to cover shelf support holes that are not used.

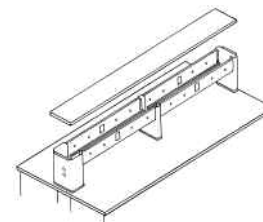

Center bench facia type reagent rack with ledge raised illustrating the parts required to make up a complete reagent rack.

Open Plain Upright



W-0005-1A

Upright without cutouts for mounting piping or electrical service.
18 1/2" H x 10 1/2" D x 2" L

Open Service Upright



W-0001-1A

Upright with four 1 1/4" diameter holes for service pipes or electrical conduit. Includes rubber grommet inserts with 1/2" diameter holes for use with smaller pipes or conduit. Order F-0300-01 plug buttons to cover unused holes.
18 1/2" H x 10 1/2" D x 2" L

Inside Facia Upright

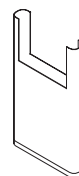

W-0013-1A

Upright with cutout to accommodate service piping and electrical conduit. Supports facia panels and ledge between ends of reagent racks more than 48" in length.
18 1/2" H x 12" D x 2" L

Outside Facia Upright



W-0014-1A

Upright designed for ends of reagent racks with facia panels.
18 1/2" H x 12" D x 2" L

Shelving Upright

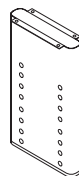

W-0201-0A

Upright designed to provide an intermediate shelf for additional storage. Holes punched on 2" centers to support PL-4410-00 shelf. Includes 4 shelf clips and plug buttons to cover unused shelf support holes.
24 1/2" H x 12" D x 2" L

Plastic Plug Button



F-0300-01 1 1/4" Dia.

Use this 1 1/4" diameter plug button to cover unused holes on W-0001-1A upright.

Outside Facia Upright

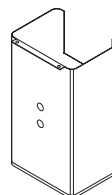

W-0021-0A

Upright with two holes on one side for mounting W-0361-00 or W-0361-0V panel mounted hot and cold water mixing faucet. Designed to provide easy access to plumbing connections. Also supports facia panels. Includes plug buttons for unused holes.
18 1/2" H x 12" D x 8" L

Steel Facia Panels

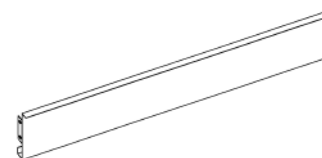

W-0033-01 33" L W-0045-01 45" L W-0057-01 57" L

7 1/2" high steel facia panel can be custom punched or cut in the field for service fitting holes and electrical cutouts required.

Reagent Racks & Shelving Systems



Fixed Wall Shelf

Many times you may need just a wall mounted shelf for laboratory materials. Kewaunee has just the answer. The fixed or adjustable shelf system allows you maximum flexibility.

Fixed Wall Mounted Shelf Brackets are designed to mount directly to the wall and furnished without mounting hardware.

Adjustable Wall Mounted Shelf Brackets are designed to mount to KF-0170-04 vertical supports and include mounting bolts and nuts. KF-0170-04 vertical supports are designed to hold a maximum of three shelves.

Wall Shelves, Reagent Rack Ledges, Intermediate Shelves and Facia Panels are a 45# particle board core faced on top and all four edges with black plastic laminate. A backer sheet covers the bottom.

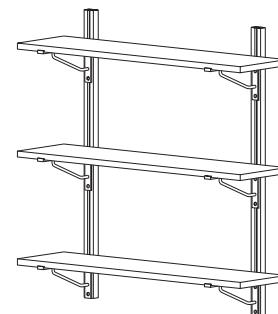

Adjustable Wall Shelving

Flat Top Shelf Brackets

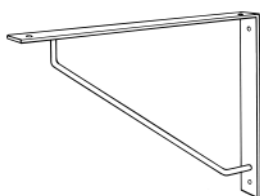

Fixed Wall Shelf Brackets

- M-0031-0A** 11" x 8" for 12" Shelf
- M-0030-0A** 15" x 10" for 16" Shelf
- M-0032-0A** 17" x 12" for 18" Shelf

Adjustable Wall Shelf Brackets

- M-0031-AD** 11" x 8" for 12" Shelf
- M-0030-AD** 15" x 10" for 16" Shelf
- M-0032-AD** 17" x 12" for 18" Shelf

Lipped Front Shelf Bracket

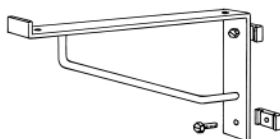

Fixed Wall Shelf Brackets

- M-0038-0A** 12¹/₈" x 6" for 12" Shelf
- M-0044-0A** 16¹/₈" x 6" for 16" Shelf
- M-0039-0A** 18¹/₈" x 6" for 18" Shelf

Adjustable Wall Shelf Brackets

- M-0038-AD** 12¹/₈" x 6" for 12" Shelf
- M-0044-AD** 16¹/₈" x 6" for 16" Shelf
- M-0039-AD** 18¹/₈" x 6" for 18" Shelf

Shelving Upright



KF-0170-04

48" L

High-strength, cold-rolled steel shelf support upright allows adjustable shelf bracket to be positioned along 48" length for maximum use of space. A pair of uprights holds a maximum of three shelf brackets.

Shelf & Ledge

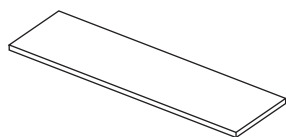

PL-4812-00 12" x 48"

1" thick, black plastic laminate shelf. May be used as wall shelf or as reagent rack ledge with W-0001-1A or W-0005-1A uprights

Reagent Rack Ledge

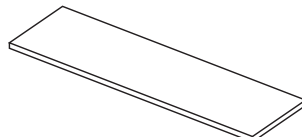

PL-4814-00 14" x 48"
PL-7214-00 14" x 72"

1" thick, black plastic laminate ledge. Provides one-inch overhang on front and back when used with W-0013-1A, W-0014-1A W-0021-1A or W-0201-0A uprights.

Intermediate Shelf

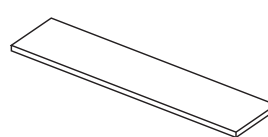

PL-4410-00 10" x 44"

1" thick, black plastic laminate shelf for creating intermediate shelf with W-0201-0A upright.

Reagent Rack Facia

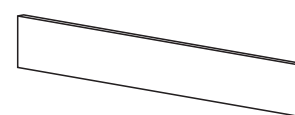

PL-4808-00 7¹/₂" x 48"

1" thick, black plastic laminate facia panel can be cut shorter if required. Service fitting holes and electrical outlet cutouts may be field-cut to match requirements.

Chalkboards, Tackboards & Pegboards

Black Chalkboard

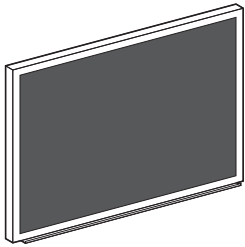

- F-5336-00** 18¹/₄" x 24¹/₄"
- F-5337-00** 24¹/₄" x 36¹/₄"
- F-5338-00** 36¹/₄" x 48¹/₄"

Black washable Duracite surface has superior writing and erasing qualities. Frame and chalktrough are heavy-gauge, anodized extruded aluminum.

Green Chalkboard

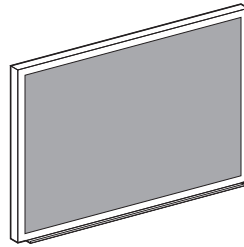

- F-5339-00** 18¹/₄" x 24¹/₄"
- F-5340-00** 24¹/₄" x 36¹/₄"
- F-5341-00** 36¹/₄" x 48¹/₄"

Green washable Duracite surface has superior writing and erasing qualities. Frame and chalktrough are heavy-gauge, anodized extruded aluminum.

White Markerboard

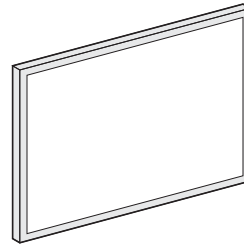

- F-5342-00** 18¹/₄" x 24¹/₄"
- F-5343-00** 24¹/₄" x 36¹/₄"
- F-5344-00** 36¹/₄" x 48¹/₄"

¹/₄" thick nonmagnetic panel with smooth white melamine writing surface. Framed with grey mylar vinyl trim with a ⁵/₈" face.

Cork Tackboard

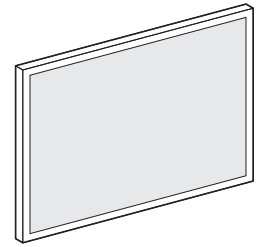

- F-5346-00** 18¹/₄" x 24¹/₄"
- F-5347-00** 24¹/₄" x 36¹/₄"
- F-5348-00** 36¹/₄" x 48¹/₄"

Resilient natural cork surface laminated to a substantial backing sheet. Framed with heavy-gauge, anodized extruded aluminum.

Stainless Steel Laboratory Pegboards

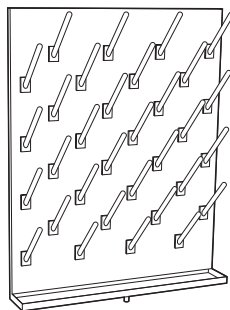

with Drip Trough
X-020004 Wall Mounted 24" long x 30" high x 3/4" thick Type 304 stainless steel pegboard with 32, 1/2" diameter, 6" long, white polypropylene pegs. Furnished with integral 4" wide drip trough and clear plastic drain tube.

X-020006 Finished Back same as X-020004 except furnished with finished back for mounting on center benches or other exposed areas.

without Drip Trough
X-020008 Wall Mounted same as X-020004 except furnished with drip deflector at bottom of pegboard instead of drip trough and drain tube.

X-020010 Finished Back same as X-020008 except furnished with finished back for mounting on center benches or other exposed areas.

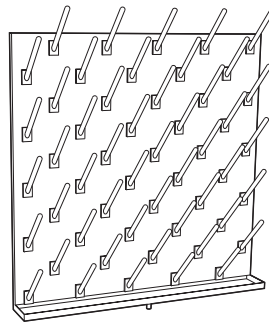

with Drip Trough
X-020005 Wall Mounted 30" long x 30" high x 3/4" thick Type 304 stainless steel pegboard with 50, 1/2" diameter, 6" long, white polypropylene pegs. Furnished with integral 4" wide drip trough and clear plastic drain tube.

X-020007 Finished Back same as X-020005 except furnished with finished back for mounting on center benches or other exposed areas.

without Drip Trough
X-020009 Wall Mounted same as X-020005 except furnished with drip deflector at bottom of pegboard instead of drip trough and drain tube.

X-020011 Finished Back same as X-020009 except furnished with finished back for mounting on center benches or other exposed areas.

Kemesin Laboratory Pegboards

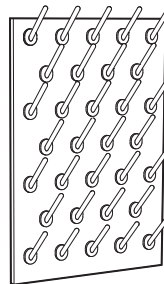

without Drip Trough
X-020014 20" long x 29" high x 1" thick black Kemresin pegboard with 32, 1/2" diameter, 5" long, black polypropylene pegs.

with Drip Trough
X-020016 same as X-020014 except furnished with Kemresin drip trough 1" high x 2 1/4" wide. Overall pegboard size, 20" long x 30" high x 2 1/4" deep.



F-2939-00 S.S. Drip Trough Formed from stainless steel, mounts to the bottom of the X-020014 pegboard to catch drips and spills. Furnished with 1/2" OD drain outlet. Size: 1 1/2" H x 2 1/2" W x 20" L

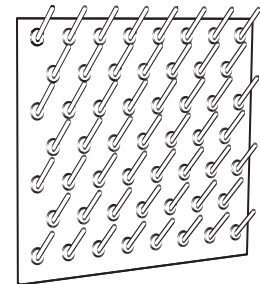

without Drip Trough
X-020015 32" long x 29" high x 1" thick black Kemresin pegboard with 53, 1/2" diameter, 5" long, black polypropylene pegs.

with Drip Trough
X-020017 same as X-020015 except furnished with Kemresin drip trough 1" high x 2 1/4" wide. Overall pegboard size, 32" long x 30" high x 2 1/4" deep.



F-2940-00 S.S. Drip Trough Formed from stainless steel, mounts to the bottom of the X-020015 pegboard to catch drips and spills. Furnished with 1/2" OD drain outlet. Size: 1 1/2" H x 2 1/2" W x 32" L

Miscellaneous Accessories

Kemresin Balance Table

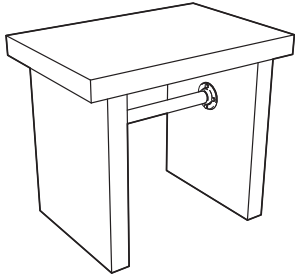

K7-302435-RB 30" High x 24" Deep x 35" Long

Work Top: 2" Thick Black Kemresin
Work Top Size: 2" Thick x 24" Deep x 35" Long
Pedestal Legs: 2" Thick Black Kemresin
Total Weight: 300 pounds

Marvel Refrigerators & Freezers

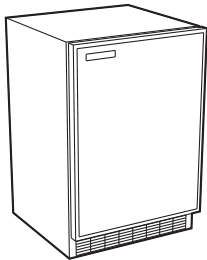

L-110 Combination Refrigerator/Freezer

Size: 34¹/₂" H x 24" D x 23⁷/₈" L — 6.1 cubic feet
Door Swing: Left or Right (User changeable)
Shelves: (1) Removable Wire
Service: Single-phase, 60 hertz, 120 volt AC

L-105 Refrigerator

Same as above except without freezer compartment.

L-115 Freezer

Same as above except entire unit is a freezer.

Gillis Stainless Steel Cart



F-5349-00 33³/₈" High x 19" Deep x 31" Long

Shelf Size: (3) 18" Deep x 27" Long
 (1" high lip on 3 sides of top & middle shelf)
Capacity: 400 pounds
Casters: (4) Black rubber – 4" Diameter – Swivel

Lund Key Cases

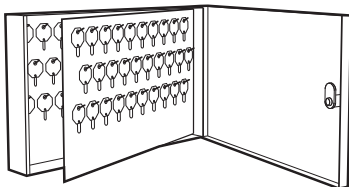

F-5332-00 11" High x 2¹/₂" Deep x 17⁵/₁₆" Long

Key Capacity: 90 Keys

F-5332-01 24³/₄" High x 2¹/₂" Deep x 17⁵/₁₆" Long

Key Capacity: 200 Keys

Miscellaneous Accessories

Pipe Enclosures

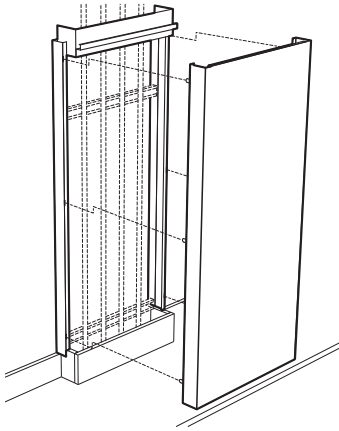

019365-WALL
Wall Bench Chase
90" H x 22¹/₄" L x 4¹¹/₁₆" D



019366-CENTER
Center Bench Chase
90" H x 22¹/₄" L x 5¹/₄" D

Made of cold rolled steel painted to match cabinets to conceal vertical service lines coming down from the ceiling to the worksurface. One side is removable for easy access with no exposed fasteners. Designed to sit on top of curb on worksurface and penetrate drop ceiling.

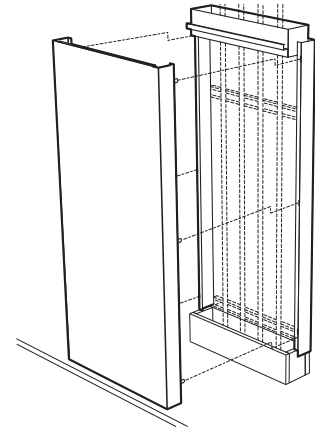

Wall Bench Chase

Center Bench Chase

Wall & Center Bench Pipe Space Kemstruts

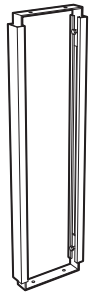

Floor mounted support to provide stability to rear overhang of fume hood tops or worksurfaces, and for mounting piping and drainlines. Adjustable to match variances in height.

K12-3006-0A	30" H x 6" D
K12-3306-0A	33" H x 6" D
K12-3606-0A	36" H x 6" D
K12-3007-0A	30" H x 7" D
K12-3307-0A	33" H x 7" D
K12-3607-0A	36" H x 7" D
K12-3008-0A	30" H x 8" D
K12-3308-0A	33" H x 8" D
K12-3608-0A	36" H x 8" D
K12-3012-0A	30" H x 12" D
K12-3312-0A	33" H x 12" D
K12-3612-0A	36" H x 12" D
K12-3014-0A	30" H x 14" D
K12-3314-0A	33" H x 14" D
K12-3614-0A	36" H x 14" D
K12-3016-0A	30" H x 16" D
K12-3316-0A	33" H x 16" D
K12-3616-0A	36" H x 16" D

Kemstrut Pipe Hangers

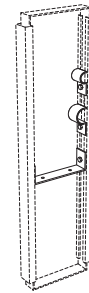

K-0005-0A	Drainline Support
M-0051-0A	Pipe Clamp for 3/8"-1/2" IPS
M-0052-0A	Pipe Clamp for 3/4"-1" IPS

Support Angles

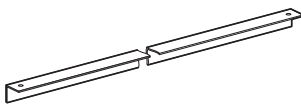

L-2034-06	6" L
L-2034-12	12" L
L-2034-18	18" L
L-2034-24	24" L
L-2034-48	48" L
L-2034-96	96" L

Formed from 16 gauge cold-rolled steel, with 1¹/₂" sides.

Corner Kemstruts

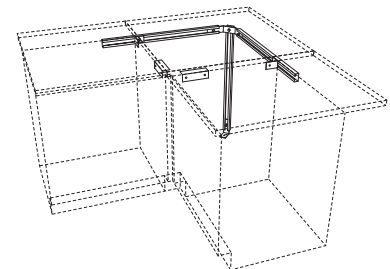

K-0020-1A	28"- 30" H
K-0016-1A	33"- 36" H

Floor and wall mounted support system for adding stability to corner tops in L-shaped furniture assemblies. Adjustable to match variances in height. Includes two support angles to attach to adjoining base cabinets.

NOTE: Kemstrut Corner Top Support Assemblies are not required when a corner base cabinet is used.

Miscellaneous Accessories

Rod Assembly Support Rods Cross Rods Rod Clamp

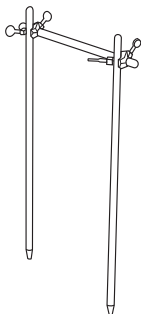

4740-00 Rod Assembly

Consists of two 0553-00 upright rods, one 0557-00 cross rod and two 0550-00 rod clamps.



0549-18 1/2" Dia. x 18" H
0549-24 1/2" Dia. x 24" H
0549-36 1/2" Dia. x 36" H
0553-00 3/4" Dia. x 36" H

Duraluminum support rods are available in 1/2" and 3/4" diameter and have a tapered end to fit 0548-00 rod sockets.



0554-00 1/2" Dia. x 39" L
0556-00 1/2" Dia. x 18" L
0557-00 3/4" Dia. x 39" L

Duraluminum cross rods are available in 1/2" and 3/4" diameter and have rounded ends

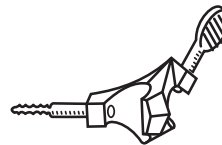

0550-00 Rod Clamp

Made of cast aluminum. Designed to clamp horizontal cross rods on vertical upright rods. Can be used for either 1/2" or 3/4" diameter rods

Rod Sockets Label Holder Base Molding Corner Guard

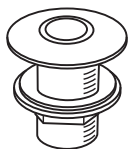

0548-00 Rod Socket

Made of chrome-plated brass. Use with 1/2" and 3/4" diameter upright rods. 1" diameter x 1 7/8" long threaded shank. Complete with locknut and washer.

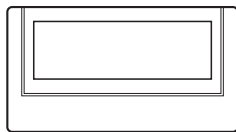

F-0260-00 Label Holder

Aluminum with adhesive back for easy installation. Holds 1 1/8" H x 2 1/2" L identification card.



F-0862-04 48" L

4" high black base molding. Made of pliable material to match variances in floor surface. Comes with high-strength adhesive applied to back.

Note: Specify number of 4' sections required.

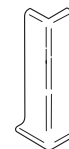

F-1368-00 Corner Guard

4" high black corner guard to finish off corner joints of base molding.

Egg Crate Type Drawer Partitions

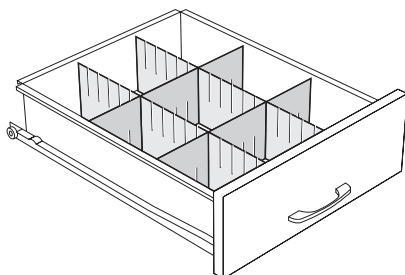

Egg-Crate Type Drawer Partitions are available for standard drawers as removable inserts.

Adjustable on one inch centers.

Corner compartments have rubber-tipped ends to prevent partitions from rattling. Furnished for front-to-back and side-to-side applications.

Front-to-Back Partitions

Drawer Height	for 18" Long Inside Dim Drawers	Partition Height
6u	ECFM060018-0000	1 1/2"
8u & 9u	ECFM080018-0000	2"
10u	ECFM100018-0000	3"
12u	ECFM120018-0000	4"
15u & 16u	ECFM150018-0000	5"

Side-to-Side Partitions

Drawer Height	for 8" Wide Inside Dim Drawers	for 11" Wide Inside Dim Drawers	for 14" Wide Inside Dim Drawers	for 17" Wide Inside Dim Drawers	for 20" Wide Inside Dim Drawers	Partition Height
6u	ECSM060008-0000	ECSM060011-0000	ECSM060014-0000	ECSM060017-0000	ECSM060020-0000	1 1/2"
8u & 9u	ECSM080008-0000	ECSM080011-0000	ECSM080014-0000	ECSM080017-0000	ECSM080020-0000	2"
10u	ECSM100008-0000	ECSM100011-0000	ECSM100014-0000	ECSM100017-0000	ECSM100020-0000	3"
12u	ECSM120008-0000	ECSM120011-0000	ECSM120014-0000	ECSM120017-0000	ECSM120020-0000	4"
15u & 16u	ECSM150008-0000	ECSM150011-0000	ECSM150014-0000	ECSM150017-0000	ECSM150020-0000	5"