

Steel Cabinet Technical Information

Inset Style Wall Bench End Views

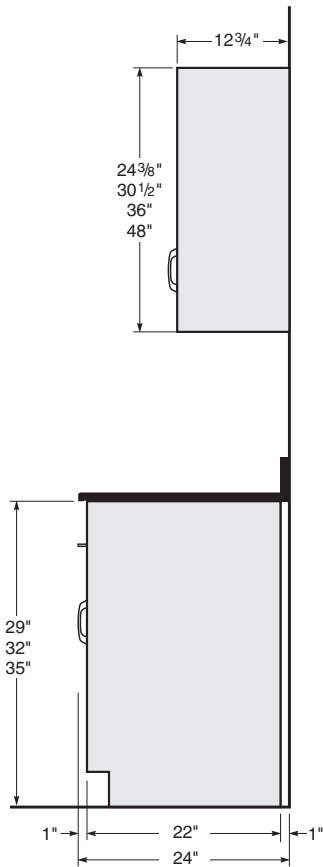

24" Deep Wall Bench

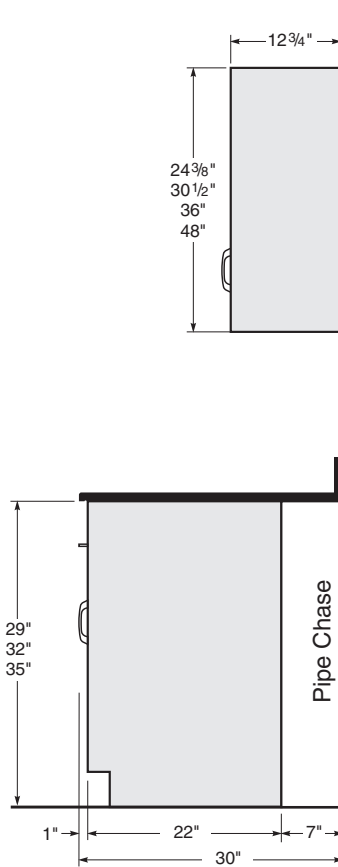

30" Deep Wall Bench

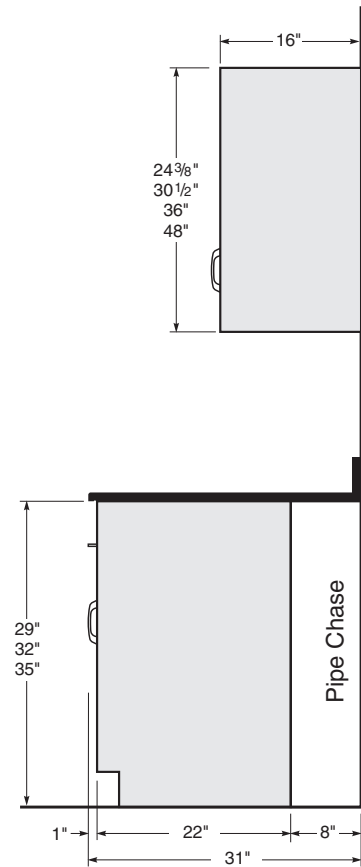

31" Deep Wall Bench

Inset Style Center Bench End Views

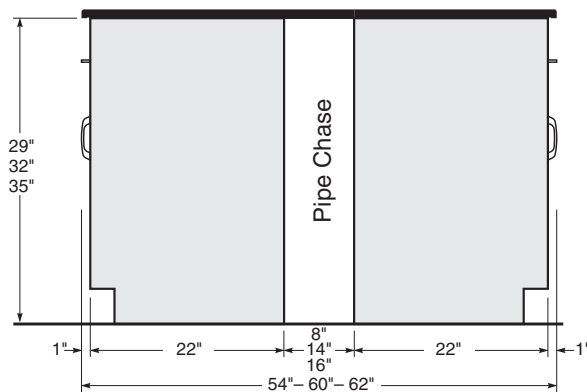

Center Bench End/Section View

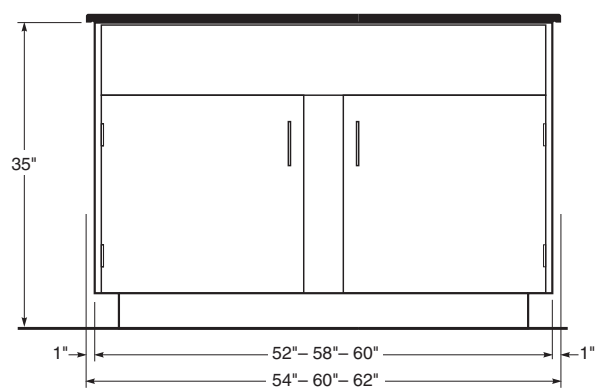

Center Bench End Sink Cabinet

Steel Cabinet Technical Information

Inset Style Full Height Storage Cabinet End Views

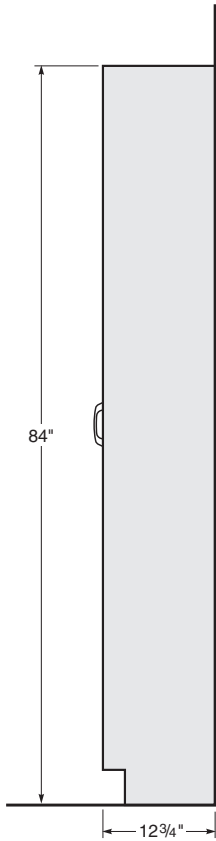

12³/₄" Deep Full Height Cabinet

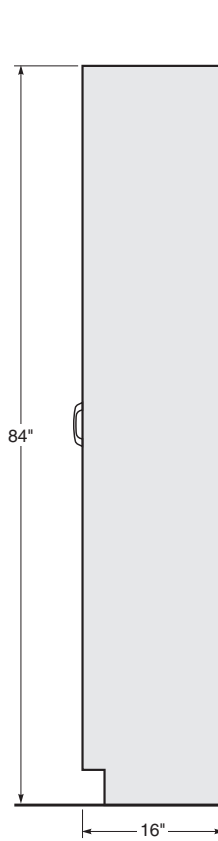

16" Deep Full Height Cabinet

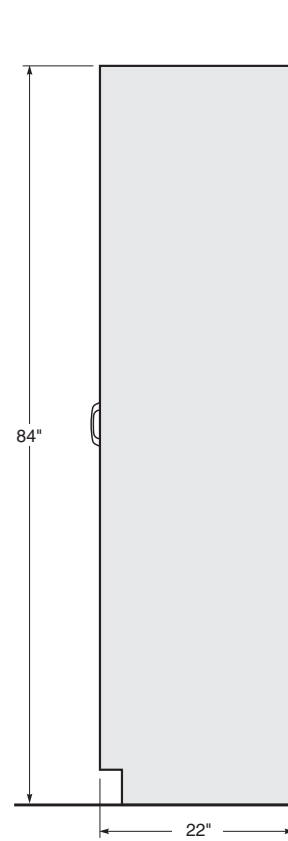

22" Deep Full Height Cabinet

Inset Style Center Bench Plan View

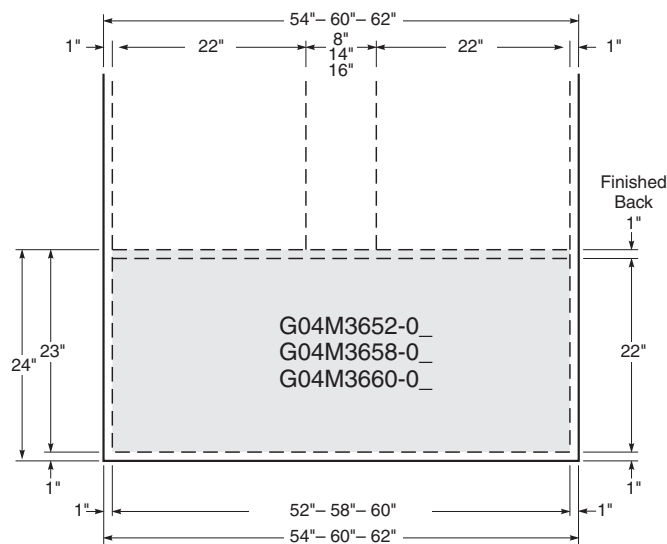

Plan View
Center Bench End Sink Cabinet

Steel Cabinet Technical Information

Full Overlay Style Wall Bench End Views

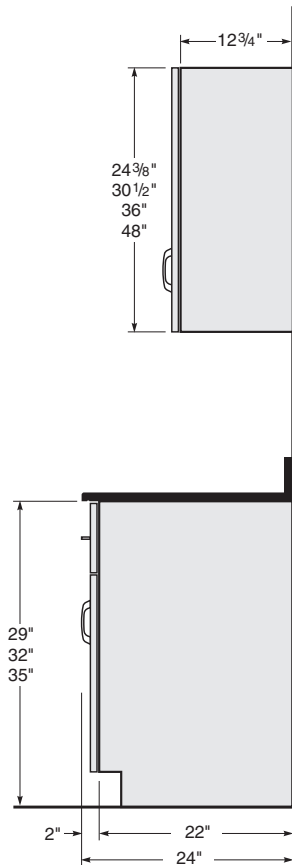

24" Deep Wall Bench

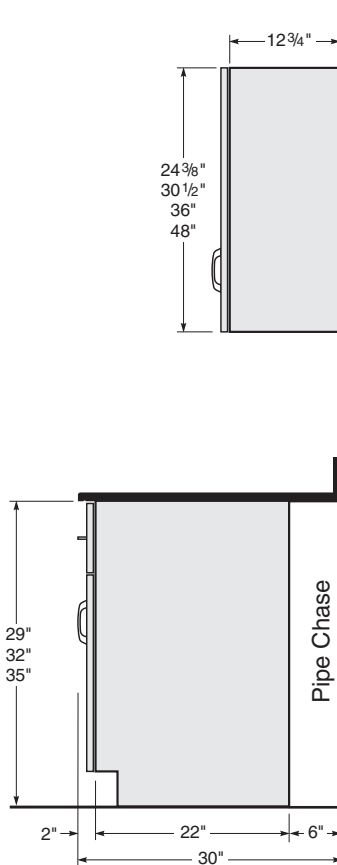

30" Deep Wall Bench

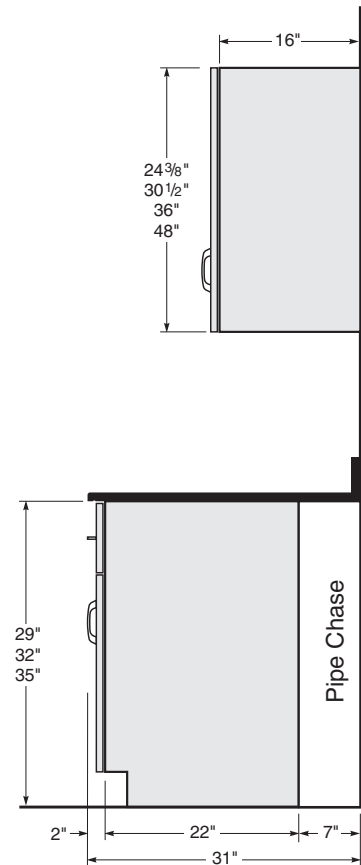

31" Deep Wall Bench

Full Overlay Style Center Bench End Views

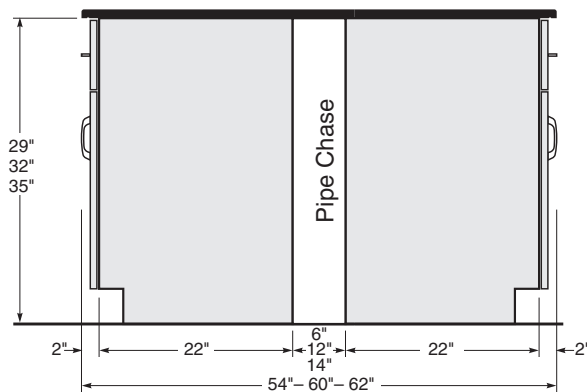

Center Bench End/Section View

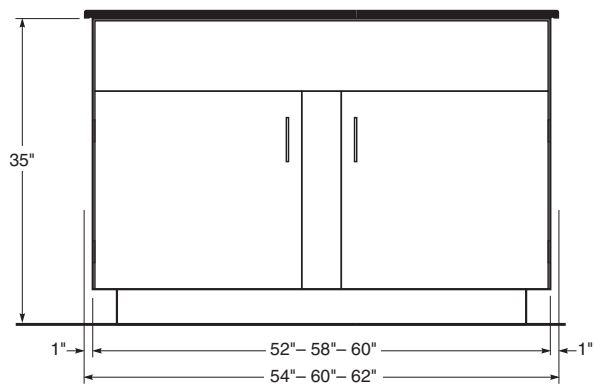

Center Bench End Sink Cabinet

Steel Cabinet Technical Information

Full Overlay Style Full Height Storage Cabinet End Views

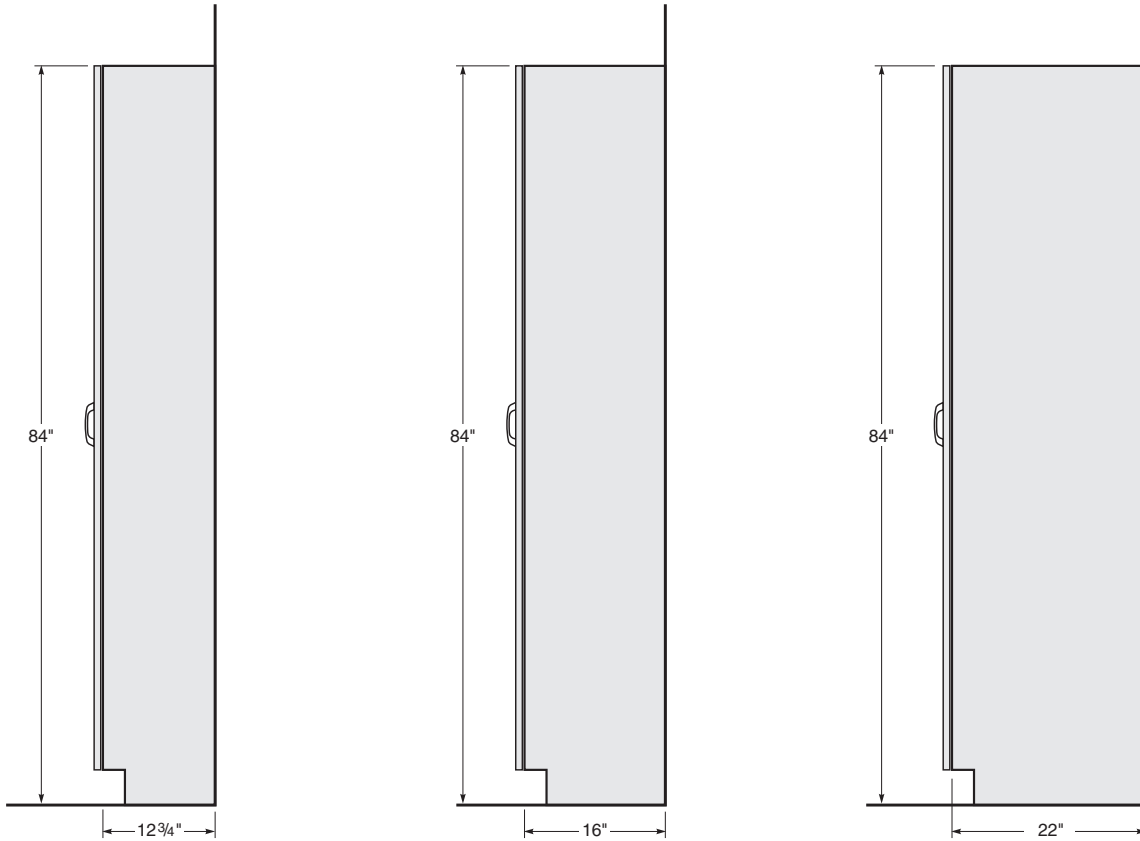

12³/₄" Deep Full Height Cabinet

16" Deep Full Height Cabinet

22" Deep Full Height Cabinet

Full Overlay Style Center Bench Plan View

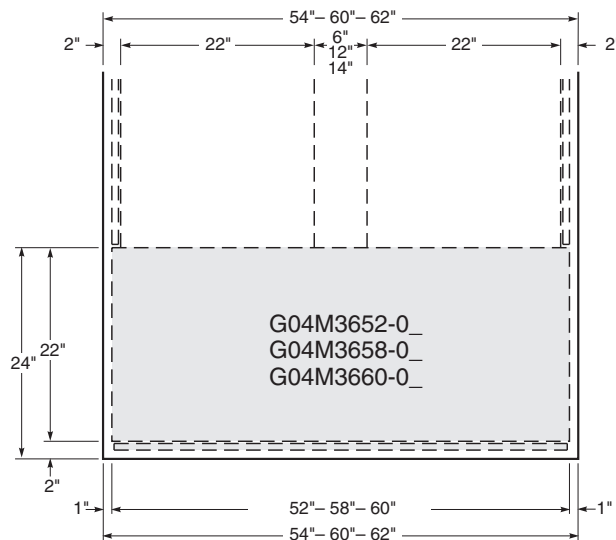

Plan View
Center Bench End Sink Cabinet

Lock Schedule Sample and Examples

Lock Schedule Examples

Keyed Different & Masterkeyed

An example of a simple lock schedule with disk tumbler locks. All locks on the project are keyed different with a single master key that can open all locks. Either disk tumbler or pin tumbler locks could be used for this arrangement.

LOCK SCHEDULE

Sheet ____ of ____

Project Name: SAMPLE PROJECT			Project/Quote Number		Date:		for Order Dept. use	
Lock Type	<input checked="" type="checkbox"/> Disk Tumbler <input type="checkbox"/> Pin Tumbler	Number of Keys per Lock	2	Number of Master Keys per change	4	Number of Grand-Master Keys per change		
Room Number	Item Number	Cabinet (all cabinets with locks must be listed)	Number of Locks	Keyed Different	Keyed Alike	Key Group	Masterkey Group	Grand-Masterkey Group
100	1	D30M3618-0101-J1	4	<input checked="" type="checkbox"/>	<input type="checkbox"/>	A		
100	1	D36M3636-0101-J1	6	<input checked="" type="checkbox"/>	<input type="checkbox"/>	A		
100	2	E40M3624-0101-J1	2	<input checked="" type="checkbox"/>	<input type="checkbox"/>	A		
105	6	D30M3624-0101-J1	4	<input checked="" type="checkbox"/>	<input type="checkbox"/>	A		
105	6	E41M3636-0101-J1	3	<input checked="" type="checkbox"/>	<input type="checkbox"/>	A		
105	6	W20M3036-0101-J1	1	<input checked="" type="checkbox"/>	<input type="checkbox"/>	A		

Keyed Alike in Sets

An example of another simple lock schedule with disk tumbler locks. On this project all the locks in each room are keyed alike, but each room is different from the other. A master key could be used in this type of keying arrangement, but in this example it is not. Either disk tumbler or pin tumbler locks could be used for this arrangement.

LOCK SCHEDULE

Sheet ____ of ____

Project Name: SAMPLE PROJECT			Project/Quote Number:		Date:		for Order Dept. use	
Lock Type	<input checked="" type="checkbox"/> Disk Tumbler <input type="checkbox"/> Pin Tumbler	Number of Keys per Lock	2	Number of Master Keys per change		Number of Grand-Master Keys per change		
Room Number	Item Number	Cabinet (all cabinets with locks must be listed)	Number of Locks	Keyed Different	Keyed Alike	Key Group	Masterkey Group	Grand-Masterkey Group
115	5	D30M3618-0101-K1	4	<input type="checkbox"/>	<input checked="" type="checkbox"/>	A		
115	5	E56M3636-0101-K1	4	<input type="checkbox"/>	<input checked="" type="checkbox"/>	A		
115	5	E41M3636-0101-K1	3	<input type="checkbox"/>	<input checked="" type="checkbox"/>	A		
126	16	E40M3624-0101-K1	2	<input type="checkbox"/>	<input checked="" type="checkbox"/>	B		
126	16	E42M3636-0101-K1	5	<input type="checkbox"/>	<input checked="" type="checkbox"/>	B		
126	17	C03M3636-0101-K1	1	<input type="checkbox"/>	<input checked="" type="checkbox"/>	B		
126	17	D30H3624-0101-K1	4	<input type="checkbox"/>	<input checked="" type="checkbox"/>	B		

Keyed Different – Masterkeyed & Grand-Masterkeyed

An example of a more complex lock schedule with pin tumbler locks. All locks are keyed different, with a separate master key for each room, and a grand-master key for the entire project. This keying arrangement could not be used with disk tumbler locks.

LOCK SCHEDULE

Sheet ____ of ____

Project Name: SAMPLE PROJECT			Project/Quote Number:		Date:		for Order Dept. use	
Lock Type	<input type="checkbox"/> Disk Tumbler <input checked="" type="checkbox"/> Pin Tumbler	Number of Keys per Lock	2	Number of Master Keys per change	5	Number of Grand-Master Keys per change	5	
Room Number	Item Number	Cabinet (all cabinets with locks must be listed)	Number of Locks	Keyed Different	Keyed Alike	Key Group	Masterkey Group	Grand-Masterkey Group
102	1	E43M3636-0200-J2	6	<input checked="" type="checkbox"/>	<input type="checkbox"/>	A	A	
102	1	E40M3618-0200-J2	2	<input checked="" type="checkbox"/>	<input type="checkbox"/>	A	A	
102	1	D30M3624-0200-J2	4	<input checked="" type="checkbox"/>	<input type="checkbox"/>	A	A	
105	3	D40M3624-0200-J2	2	<input checked="" type="checkbox"/>	<input type="checkbox"/>	B	A	
105	3	D30M3624-0200-J2	4	<input checked="" type="checkbox"/>	<input type="checkbox"/>	B	A	
1113	9	D32M3636-0200-J2	8	<input checked="" type="checkbox"/>	<input type="checkbox"/>	C	A	
1113	9	C03M3636-0200-J2	1	<input checked="" type="checkbox"/>	<input type="checkbox"/>	C	A	
1113	10	D30M3624-0200-J2	4	<input checked="" type="checkbox"/>	<input type="checkbox"/>	C	A	

