

# Alpha System Accessories

**Features:**

- Tackboards
- Markerboards
- Pegboards
- Hanging Brackets
- Heavy Duty Benches
- Motorized Adjustable Height Bench
- Rack Mount Equipment Cabinet
- Undercounter Refrigerators & Freezers
- Balance Tables
- Key Cases
- Base Molding
- Service Fittings
- Water Faucets
- Distilled/Deionized Water Faucets
- Laboratory Safety Fittings
- Vandal-Resistant Fittings
- Epoxy Resin Cupsinks & Tub Sinks
- Stainless Steel Sinks
- Electrical Fixtures & Pedestals
- Chairs & Stools

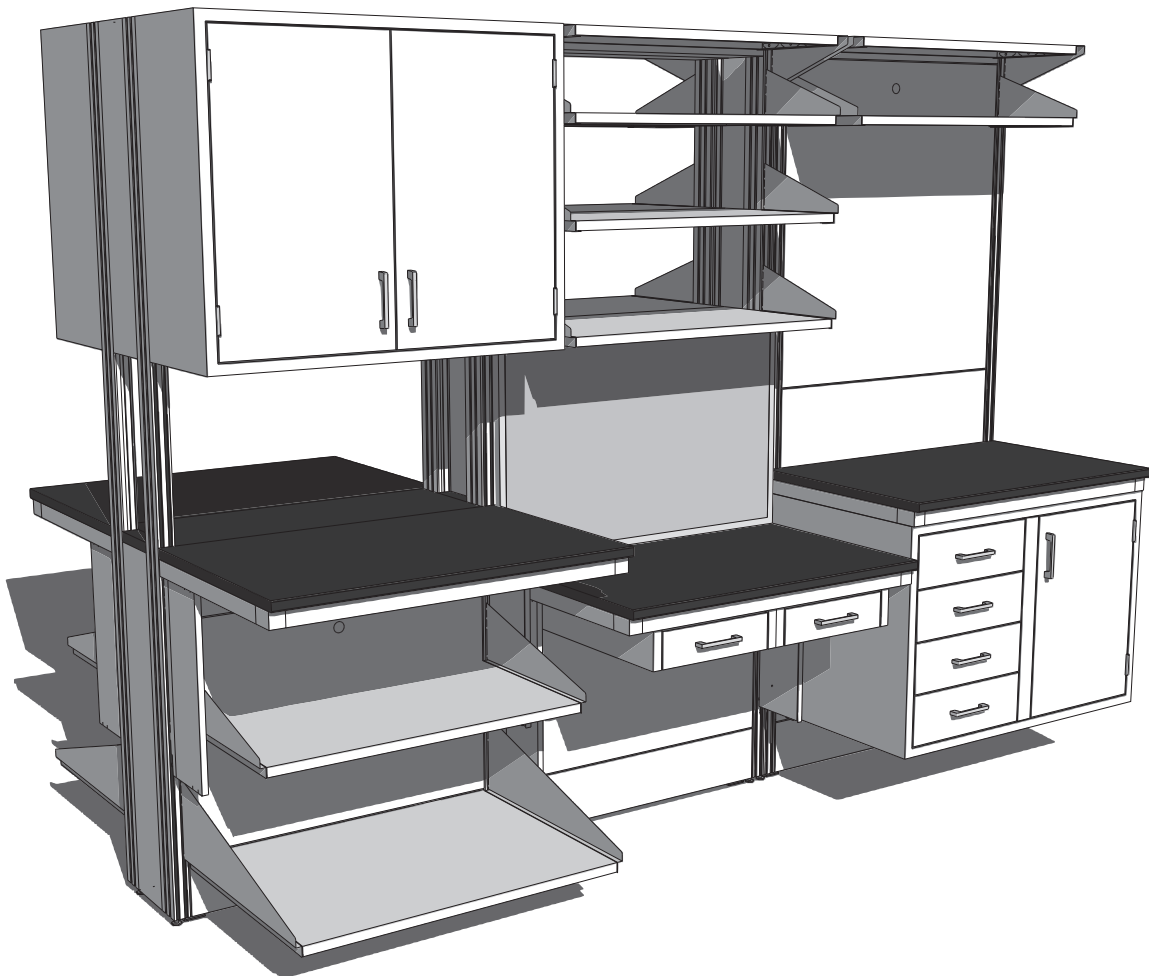

# Tackboards & Markerboards

## Tackboards and Markerboards

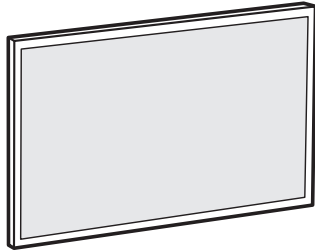

Length	Height	Tackboard	Markerboard
24"	18"	<b>F-5418-24</b>	<b>F-5518-24</b>
30"	18"	<b>F-5418-30</b>	<b>F-5518-30</b>
36"	18"	<b>F-5418-36</b>	<b>F-5518-36</b>
42"	18"	<b>F-5418-42</b>	<b>F-5518-42</b>
48"	18"	<b>F-5418-48</b>	<b>F-5518-48</b>
54"	18"	<b>F-5418-54</b>	<b>F-5518-54</b>
60"	18"	<b>F-5418-60</b>	<b>F-5518-60</b>
66"	18"	<b>F-5418-66</b>	<b>F-5518-66</b>
72"	18"	<b>F-5418-72</b>	<b>F-5518-72</b>
<hr/>			
24"	24"	<b>F-5424-24</b>	<b>F-5524-24</b>
30"	24"	<b>F-5424-30</b>	<b>F-5524-30</b>
36"	24"	<b>F-5424-36</b>	<b>F-5524-36</b>
42"	24"	<b>F-5424-42</b>	<b>F-5524-42</b>
48"	24"	<b>F-5424-48</b>	<b>F-5524-48</b>
54"	24"	<b>F-5424-54</b>	<b>F-5524-54</b>
60"	24"	<b>F-5424-60</b>	<b>F-5524-60</b>
66"	24"	<b>F-5424-66</b>	<b>F-5524-66</b>
72"	24"	<b>F-5424-72</b>	<b>F-5524-72</b>
<hr/>			
24"	30"	<b>F-5430-24</b>	<b>F-5530-24</b>
30"	30"	<b>F-5430-30</b>	<b>F-5530-30</b>
36"	30"	<b>F-5430-36</b>	<b>F-5530-36</b>
42"	30"	<b>F-5430-42</b>	<b>F-5530-42</b>
48"	30"	<b>F-5430-48</b>	<b>F-5530-48</b>
54"	30"	<b>F-5430-54</b>	<b>F-5530-54</b>
60"	30"	<b>F-5430-60</b>	<b>F-5530-60</b>
66"	30"	<b>F-5430-66</b>	<b>F-5530-66</b>
72"	30"	<b>F-5430-72</b>	<b>F-5530-72</b>

Tackboards and Markerboards may be attached to Modules using either Hanging Rails or Hanging Brackets.

**Order Brackets or Rails separately.**

## Hanging Brackets

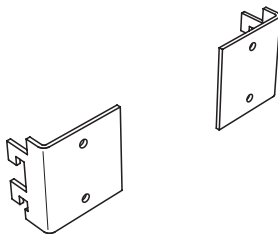

Part Number

1 pair **F47M0203-00**

Hanging Brackets are designed to attach Tackboards, Markerboards, and other lightweight accessories to the slots on the Module Uprights. Furnished in pairs.

## Base Molding



### F-0862-04 Base Molding –

48" long, 4" high black base molding. Made of pliable material to match variances in floor surface. Comes with high-strength adhesive applied to back.

**Note: Specify number of 4-foot sections required.**

## Corner Guard

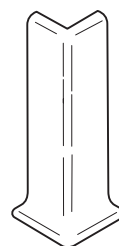

### F-1368-00 Base Molding

**Corner Guard** – 4" high black corner guard to finish off outside corner joints of base molding.

## Laboratory Pegboards

### Stainless Steel Laboratory Pegboards

### Kemresin® Laboratory Pegboards

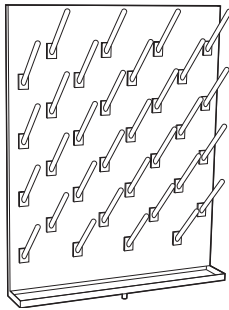

**with Drip Trough**  
**X-020004** Wall Mounted  
24" long x 30" high x 3/4" thick  
Type 304 stainless steel pegboard  
with 32, 1/2" diameter, 6" long,  
white polypropylene pegs.  
Furnished with integral 4" wide  
drip trough and clear plastic  
drain tube.

**X-020006** Finished Back  
same as X-020004 except  
furnished with finished back for  
mounting on center benches or  
other exposed areas.

**without Drip Trough**  
**X-020008** Wall Mounted  
same as X-020004 except  
furnished with drip deflector at  
bottom of pegboard instead of  
drip trough and drain tube.

**X-020010** Finished Back  
same as X-020008 except  
furnished with finished back for  
mounting on center benches or  
other exposed areas.

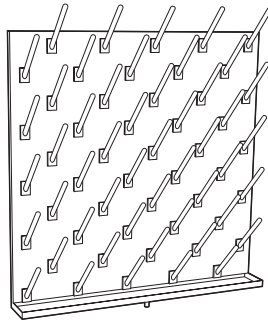

**with Drip Trough**  
**X-020005** Wall Mounted  
30" long x 30" high x 3/4" thick  
Type 304 stainless steel pegboard  
with 50, 1/2" diameter, 6" long,  
white polypropylene pegs.  
Furnished with integral 4" wide  
drip trough and clear plastic  
drain tube.

**X-020007** Finished Back  
same as X-020005 except  
furnished with finished back for  
mounting on center benches or  
other exposed areas.

**without Drip Trough**  
**X-020009** Wall Mounted  
same as X-020005 except  
furnished with drip deflector at  
bottom of pegboard instead of  
drip trough and drain tube.

**X-020011** Finished Back  
same as X-020009 except  
furnished with finished back for  
mounting on center benches or  
other exposed areas.

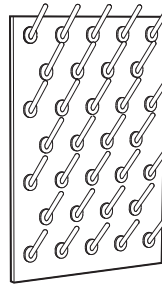

**without Drip Trough**  
**X-020014**  
20" long x 29" high x 1" thick  
black Kemresin pegboard with  
32, 1/2" diameter, 5" long, black  
polypropylene pegs.

**with Drip Trough**  
**X-020016**  
same as X-020000 except  
furnished with Kemresin drip  
trough 1" high x 1 7/8" wide.  
Overall pegboard size, 20" long x  
30" high x 2 1/4" deep.

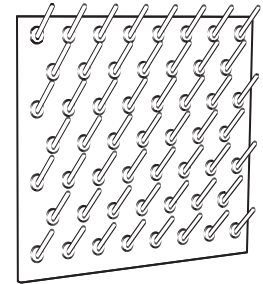

**without Drip Trough**  
**X-0200015**  
32" long x 29" high x 1" thick  
black Kemresin pegboard with  
53, 1/2" diameter, 5" long, black  
polypropylene pegs.

**with Drip Trough**  
**X-020017**  
same as X-020001 except  
furnished with Kemresin drip  
trough 1" high x 1 7/8" wide.  
Overall pegboard size, 32" long x  
30" high x 2 1/4" deep.



**F-2939-00** S.S. Drip Trough  
Formed from stainless steel,  
mounts to the bottom of the  
X-020000 pegboard to catch  
drips and spills. Furnished with  
1/2" OD drain outlet. Size: 1 1/2" H x  
2 1/2" W x 20" L



**F-2940-00** S.S. Drip Trough  
Formed from stainless steel,  
mounts to the bottom of the  
X-020001 pegboard to catch  
drips and spills. Furnished with  
1/2" OD drain outlet. Size: 1 1/2" H x  
2 1/2" W x 32" L

Laboratory Pegboards may be attached to Modules using Hanging Rails or attaching to Enclosure Panels

**Order Rails separately.**

### Hanging Rails

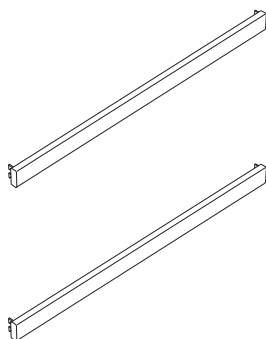

Length	Part Number	
24"	<b>F49M0224-00</b>	1 pair
30"	<b>F49M0230-00</b>	1 pair
36"	<b>F49M0236-00</b>	1 pair
42"	<b>F49M0242-00</b>	1 pair
48"	<b>F49M0248-00</b>	1 pair
54"	<b>F49M0254-00</b>	1 pair
60"	<b>F49M0260-00</b>	1 pair
66"	<b>F49M0266-00</b>	1 pair
72"	<b>F49M0272-00</b>	1 pair

# Miscellaneous Accessories

## Kemresin Balance Table

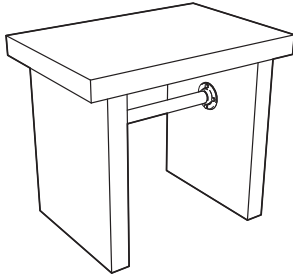

**K7-302435-RB** 30" High x 24" Deep x 35" Long

**Work Top:** 2" Thick Black Kemresin  
**Work Top Size:** 2" Thick x 24" Deep x 35" Long  
**Pedestal Legs:** 2" Thick Black Kemresin  
**Total Weight:** 300 pounds

## Marvel Refrigerators & Freezers

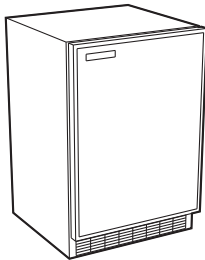

**L-110** Combination Refrigerator/Freezer

**Size:** 34<sup>1</sup>/<sub>2</sub>" H x 24" D x 23<sup>7</sup>/<sub>8</sub>" L — 6.5 cubic feet  
**Door Swing:** Left or Right (User changeable)  
**Shelves:** (1) Removable Wire  
**Service:** Single-phase, 60 hertz, 120 volt AC

**L-105** Refrigerator

Same as above except without freezer compartment.

**L-115** Freezer

Same as above except entire unit is a freezer.

## Gillis Stainless Steel Cart



**F-5349-00** 33<sup>3</sup>/<sub>8</sub>" High x 19" Deep x 31" Long

**Shelf Size:** (3) 18" Deep x 27" Long  
 (1" high lip on 3 sides of top & middle shelf)  
**Capacity:** 400 pounds  
**Casters:** (4) Black rubber – 4" Diameter – Swivel

## Lund Key Cases

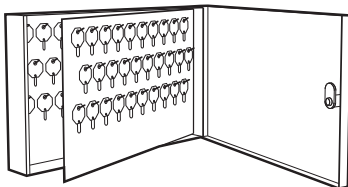

**F-5332-00** 11" High x 2<sup>1</sup>/<sub>2</sub>" Deep x 17<sup>5</sup>/<sub>16</sub>" Long

**Key Capacity:** 90 Keys

**F-5332-01** 24<sup>3</sup>/<sub>4</sub>" High x 2<sup>1</sup>/<sub>2</sub>" Deep x 17<sup>5</sup>/<sub>16</sub>" Long

**Key Capacity:** 200 Keys

# Adjustable Bench & Rack Mount Enclosure

## Motorized Adjustable Height Technical Workstation Bench

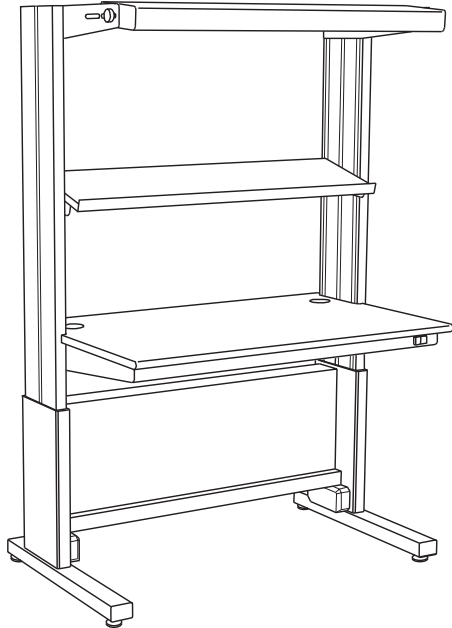

Depth	Length	Part Number
30"	48"	<b>TWS01-3048-00</b>
30"	60"	<b>TWS01-3060-00</b>
30"	72"	<b>TWS01-3072-00</b>
36"	48"	<b>TWS01-3648-00</b>
36"	60"	<b>TWS01-3660-00</b>
36"	72"	<b>TWS01-3672-00</b>

This Technical Workstation Bench incorporates a motorized control that permits worksurface height adjustment from 28<sup>1</sup>/<sub>2</sub>" to 40<sup>1</sup>/<sub>2</sub>" with just the touch of a switch. The bench includes a high pressure laminate worksurface, a 12" deep steel tilting shelf, a two-tube fluorescent overhead task light with rocker switch and a fused power outlet strip with 3-wire cord and plug. The worksurface, shelf and task light move as one but can be individually adjusted manually along the height of the upper column.

Load capacity; 750 pounds.

**Lamps not included with task light.**

## Rack Mount Equipment Enclosure

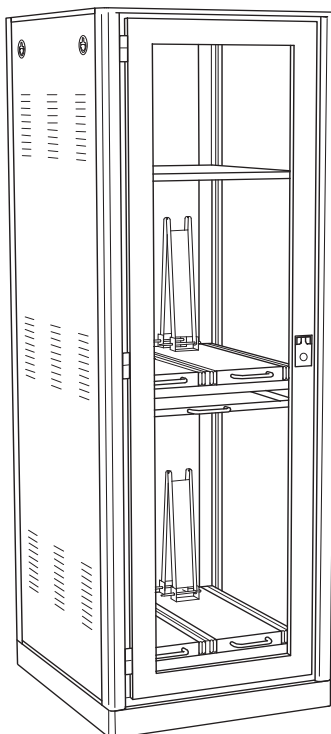

Length	Part Number
25"	<b>TWS50-2925-00</b>

**TWS50-2925-00** (shown) 28<sup>1</sup>/<sub>2</sub>" deep x 24<sup>7</sup>/<sub>8</sub>" long by 76" high Rack Mount Equipment Enclosure is specifically designed to handle the needs of a small computer network, but can be used for any electronic equipment that uses a standard 19" rack mounting.

The exterior of the enclosure is fitted with a framed glass front door, a louvered rear door and two removable louvered side panels. Both doors are mounted on removable hinges. Both the doors and the panels are furnished with locks.

The enclosure interior is furnished with four half-width sliding shelves with cable management arms, a sliding keyboard tray, a fixed monitor shelf, a 48" long ten outlet power strip and a 10" diameter ventilation fan mounted in the top. All shelves are adjustable in height and removable.