

General Plumbing Information

Recommended Supply Line Pressures

Gas	0.216 psi
Air (Ordinary)	15 psi
Air (Air Powered Stirrer Operation)	40 psi
Vacuum (Ordinary)	18"-22" of Mercury
Vacuum (High)	28.5" of Mercury
Hot and Cold Water	Local Pressure
Steam (Low Pressure)	0-15 psi as required
Steam (High Pressure)	15-30 psi as required

Service & Rough-In Abbreviations

A – Air
E – Electric - 115 volt AC
G – Gas
N – Nitrogen
O – Oxygen
S – Steam
V – Vacuum
W – Waste
CW – Cold Water
DW – Distilled Water
HV – Hood Vent
HW – Hot Water
WV – Waste Vent

Service Fitting Index Color Coding

When ordering service fittings, specify service required, so that the proper index button(s) will be supplied.

Air – Orange
Cold Water – Dark Green
Distilled Water – White
Gas – Dark Blue
Hot Water – Red
Hydrogen – Pink
Nitrogen – Brown
Oxygen – Light Green
Special Gases – Light Blue
Steam – Black
Vacuum – Yellow

Recommended Pipe & Drain Line Sizes

Service	No. Of Outlets	Pipe Size	Pipe Materials
STEAM	1-8	3/8"	In accordance with governing codes
	9-16	1/2"	
	17-24	3/4"	
*WATER	1-10	1/2"	In accordance with governing codes
	11-18	3/4"	
	19-24	1"	
GAS	1-12	3/8"	In accordance with governing codes
	13-18	1/2"	
	19-24	3/4"	
	25-30	1"	
AIR or VACUUM	1-8	3/8"	In accordance with governing codes
	9-16	1/2"	
	17-24	3/4"	
	Fittings or Filter Pumps	Pipe Size	Pipe Material
DRAIN LINE	1-6 Fittings or 4 Pumps	1 1/2"	In accordance with governing codes
	7-10 Fittings or 8 Pumps	2"	

* If table is equipped with a series of filter pumps (aspiration), next larger pipe size should be used.

Open Reagent Rack Horizontal Pipe Spacing –

Water pipe lines should always be the lowest and a minimum of 9" above the working surface. Electric conduit should always be the uppermost service line. (Insulated pipe will require a greater spacing than indicated below.)

Pipe Diameters	Minimum Vertical Spacing Between Centerlines of 2 Service Pipe Lines
3/8" and 3/8"	2"
3/8" and 1/2"	2"
1/2" and 1/2"	2"
1/2" and 3/4"	2 1/2"
3/4" and 3/4"	2 1/2"
3/4" and 1"	3"
1" and 1"	3"

NOTE: For information not supplied, or if additional details are required, contact your local Kewaunee Representative.

Minimum Spacing Between Fittings

The drawings below show the allowable minimum spacing between service and electrical fittings on laboratory bench tops and ledges.

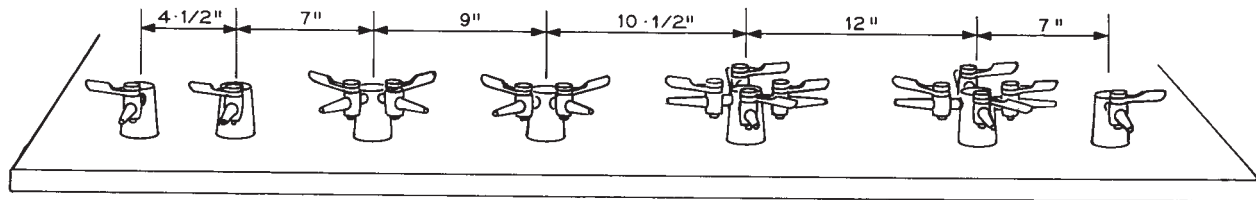

Laboratory Service Fittings

Laboratory Ball Valves (for use with air, vacuum or gases – not to be used for liquids, steam or oxygen)

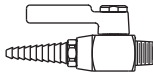

W-0242-00 Gas, Air or Vacuum Valve is chrome plated brass. Valve provides on/off control of gas, air or vacuum at pressures up to 75 PSI. $\frac{3}{8}$ " I.P.S. male inlet. **Specify service desired.**

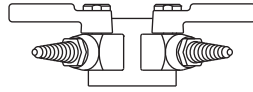

W-0286-02 Double Gas, Air or Vacuum Fitting (curb or panel mounted) is chrome plated brass. Consists of two-way 70° outlet panel flange and two laboratory ball valves. Complete with $\frac{3}{8}$ " I.P.S. tank nipple, locknut and washer. **Specify service desired.**

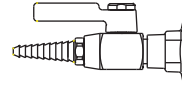

W-0287-00 Gas, Air or Vacuum Fitting (curb or panel mounted) is chrome plated brass. Consists of a single outlet panel flange and a laboratory ball valve. Complete with a $\frac{3}{8}$ " I.P.S. tank nipple, locknut and washer. **Specify service desired.**

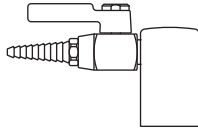

W-0260-00 Gas, Air or Vacuum Deck Mounted Fitting is chrome plated brass. Consists of a single outlet turret with a laboratory ball valve. Complete with a $\frac{3}{8}$ " I.P.S. tank nipple, locknut and washer. **Specify service desired.**

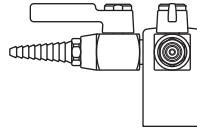

W-0263-00 Double Gas, Air or Vacuum Deck Mounted Fitting Same as No. W-0260-00 except consists of a 2-way 90° outlet turret and two laboratory ball valves. Complete with a $\frac{3}{8}$ " I.P.S. tank nipple, locknut and washer. **Specify service desired.**

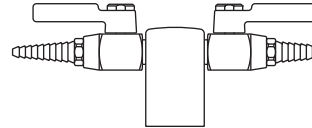

W-0266-00 Double Gas, Air or Vacuum Deck Mounted Fitting Same as No. W-0260-00, except consists of a 2-way 180° outlet turret and two laboratory ball valves. Complete with a $\frac{3}{8}$ " I.P.S. tank nipple, locknut and washer. **Specify service desired.**

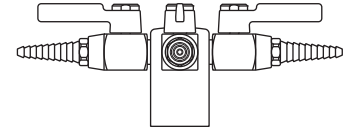

W-0272-00 Quadruple Gas, Air or Vacuum Deck Mounted Fitting Same as W-0260-00, except consists of a 4-way outlet turret and four valves. Complete with a $\frac{3}{8}$ " I.P.S. tank nipple, locknut and washer. **Specify service desired.**

Needle Point Cock Valves (for use with air, vacuum or gases – not to be used for liquids or steam)

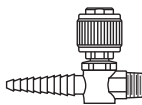

W-0243-00 Gas, Air or Vacuum Valve is chrome plated brass. Single needle point valve with integral straight serrated hose ends. Brass floating cone and integral brass seat. Valve provides metering control of laboratory gases at pressures up to 60 PSI. $\frac{3}{8}$ " I.P.S. male inlet. **Specify service desired.**

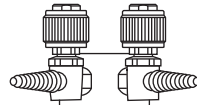

W-0400-00 Double Gas, Air or Vacuum Fitting (curb or panel mounted) with two needle point valves with integral serrated hose ends. Brass floating cone and integral brass seat. Complete with a $\frac{3}{8}$ " I.P.S. tank nipple, locknut and washer. **Specify service desired.**

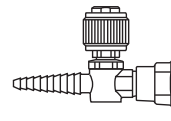

W-0401-00 Gas, Air or Vacuum Fitting (curb or panel mounted) Same as No. W-0400-00 except single needle point valve. Complete with a $\frac{3}{8}$ " I.P.S. tank nipple, locknut and washer. **Specify service desired.**

NOTE: If valve is to be used for oxygen service, order W-0243-01.

Laboratory Service Fittings

Needle Point Cock Valves (for use with air, vacuum or gases – not to be used for liquids or steam)

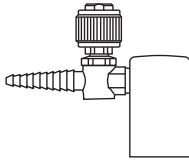

W-0259-00 Single Needle Cock Deck Mounted Fitting
Turret Base is chrome plated brass. Single needle point valve with integral straight serrated hose end. Complete with a $\frac{3}{8}$ " I.P.S. tank nipple, locknut and washer.
Specify service desired.

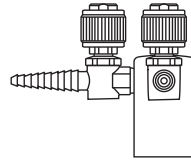

W-0402-00 Double Needle Cock Deck Mounted Fitting
Turret Base is chrome plated brass. Two needle point valves with integral straight serrated hose ends at 90°. Complete with a $\frac{3}{8}$ " I.P.S. tank nipple, locknut and washer.
Specify service desired.

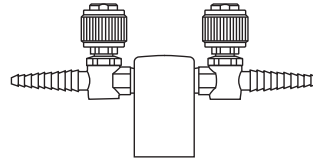

W-0403-00 Double Needle Cock Deck Mounted Fitting
Turret Base is chrome plated brass. Same as No. W-0402-00 except integral straight serrated hose ends are at 180°. Complete with a $\frac{3}{8}$ " I.P.S. tank nipple, locknut and washer.
Specify service desired.

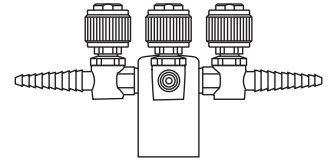

W-0404-00 Quadruple Needle Cock Deck Mounted Fitting
Turret Base is chrome plated brass. Four needle point valves with integral straight serrated hose ends. Complete with a $\frac{3}{8}$ " I.P.S. tank nipple, locknut and washer.
Specify service desired.

Water Valve

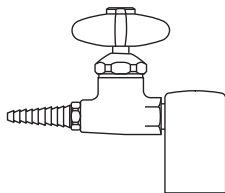

W-0306-00 Water Fitting (deck or panel mounted)
Made of chrome plated brass. Consists of a single outlet turret and a straight water valve with removable straight serrated hose connector. Complete with a $\frac{3}{8}$ " I.P.S. tank nipple, locknut and washer.

Steam Valves

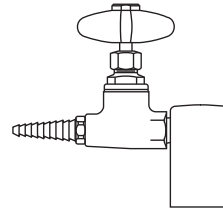

W-0300-00 Steam Fitting (deck or panel mounted)
Made of chrome plated brass. Consists of a single outlet turret and a straight steam valve. Designed for maximum steam pressure of 20 psi. Complete with a $\frac{3}{8}$ " I.P.S. tank nipple, locknut and washer.

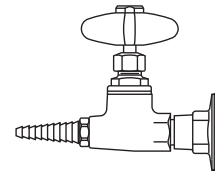

W-0301-00 Steam Fitting (curb or panel mounted)
Made of chrome plated brass. Consists of a single outlet panel flange and a straight steam valve. Designed for maximum steam pressure of 20 psi. Complete with a $\frac{3}{8}$ " I.P.S. tank nipple, locknut and washer.

Multiple Service Fitting

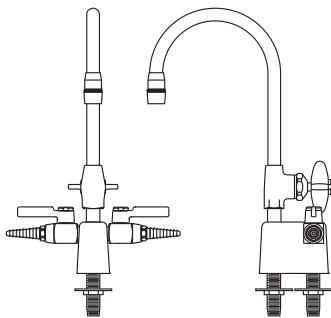

W-0273-02 Deck Mounted Combination Water/Gas Fitting
Made of chrome plated brass. Water faucet has a 6" spread gooseneck with removable aerator outlet and disc type valve. Includes a two-way turret with two laboratory ball valves set at 180°. Complete with two $\frac{3}{8}$ " I.P.S. tank nipples, locknuts and washers.
(Specify service desired for ball valves.)

W-0273-VB Deck Mounted Combination Water/Gas Fitting
Same as W-0273-02 except furnished with vacuum breaker type gooseneck and removable straight serrated hose connector.
(Specify service desired for ball valves.)

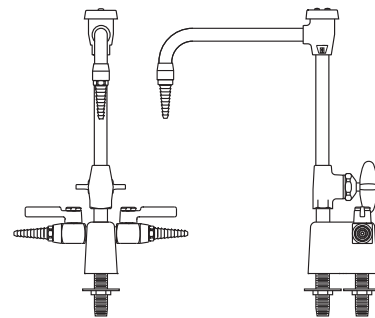

W-0274-VB Deck Mounted Combination Water/Gas Fitting
Made of chrome plated brass. Water faucet has a 8" spread vacuum breaker type gooseneck with removable straight serrated hose connector and disc type valve. Includes a two-way turret with two laboratory ball valves set at 180°. Complete with two $\frac{3}{8}$ " I.P.S. tank nipples, locknuts and washers.
(Specify service desired for valves.)

W-0274-02 Deck Mounted Combination Water/Gas Fitting
Same as W-0274-VB except furnished with standard gooseneck and removable aerator outlet.
(Specify service desired for valves.)

Laboratory Service Fittings

Single Water Faucet

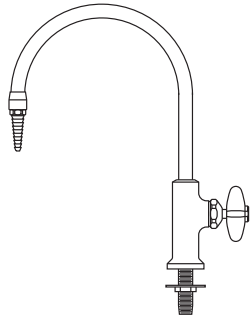

W-0337-00 Deck Mounted Gooseneck Water Faucet
 Chrome plated brass with an 8" spread rigid gooseneck. Removable straight serrated hose connector. Valve is disc type with a renewable internal assembly. Faucet is complete with a 3/8" I.P.S. tank nipple, locknut and washer.

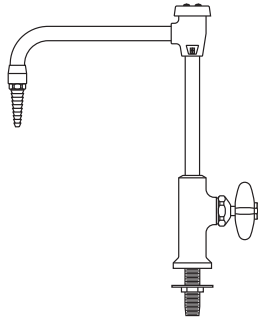

W-0337-0V Deck Mounted Vacuum Breaker Gooseneck Water Faucet Same as W-0337-00 except furnished with 8" spread rigid vacuum breaker type gooseneck.

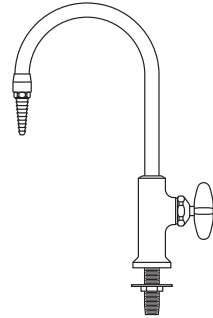

W-0337-06 Deck Mounted Gooseneck Water Faucet
 Same as W-0337-00 except furnished with 6" spread rigid gooseneck

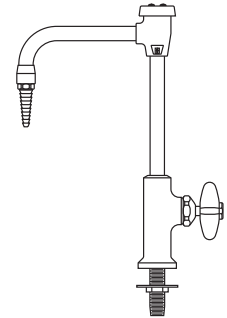

W-0337-6V Deck Mounted Vacuum Breaker Gooseneck Water Faucet Same as W-0337-0V except furnished with 6" spread rigid vacuum breaker type gooseneck.

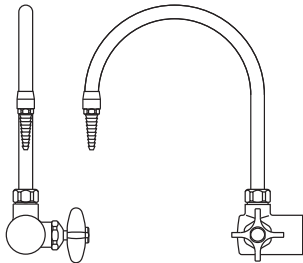

W-0350-00 Right Hand Curb Mounted Gooseneck Water Faucet Made of chrome plated brass. Has an 8" spread rigid gooseneck with removable straight serrated hose connector. Valve is disc type with renewable internal assembly. Flanged inlet is complete with 1/2" I.P.S. tank nipple, locknut and washer.

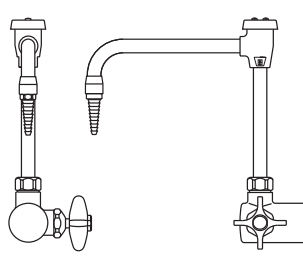

W-0350-0V Right Hand Curb Mounted Vacuum Breaker Gooseneck Water Faucet
 Same as W-0350-00 except supplied with vacuum breaker type gooseneck.

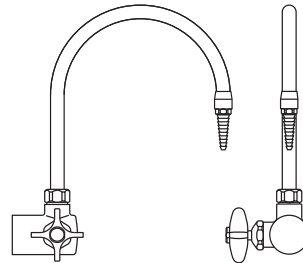

W-0351-00 Left Hand Curb Mounted Gooseneck Water Faucet Same as W-0350-00 except supplied with valve handle on left.

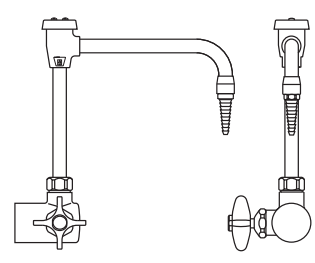

W-0351-0V Left Hand Curb Mounted Vacuum Breaker Gooseneck Water Faucet
 Same as W-0350-0V except supplied with valve handle on left.

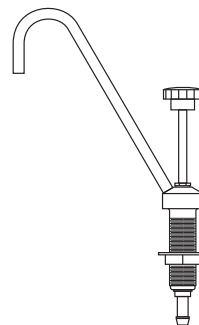

W-0405-00 Portable Pump Gooseneck Faucet for laboratory demonstration table. Made of chrome plated brass with 7 5/8" spread, rigid, 1/4" I.P.S. gooseneck. Faucet/pump body is complete with an integral threaded mounting shank and flanged locknut. 5/8" O.D. hose connector inlet.

Laboratory Service Fittings

Mixing Faucet

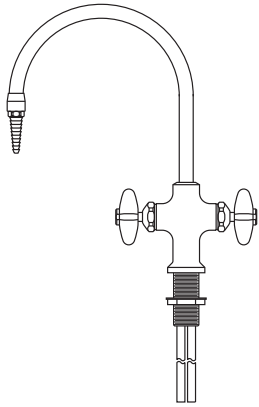

W-0340-00 Deck Mounted Hot and Cold Water Mixing Gooseneck Faucet Made of chrome plated brass with an 8" spread rigid gooseneck. Removable straight serrated hose connector. Valves are disc type with renewable internal assemblies. Faucet body is complete with an 1 $\frac{3}{16}$ " integral threaded mounting shank and a flanged locknut. Furnished with $\frac{3}{8}$ " flexible copper tubing water inlets.

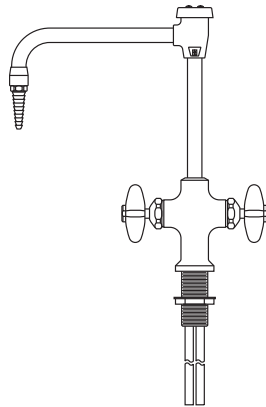

W-0340-0V Deck Mounted Hot and Cold Water Mixing Vacuum Breaker Gooseneck Faucet Same as W-0340-00 except supplied with vacuum breaker type gooseneck.

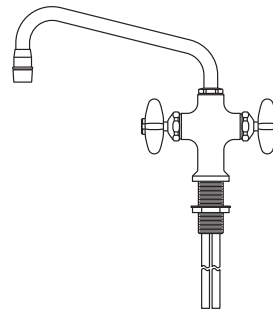

W-0333-00 Deck Mounted Hot and Cold Water Mixing Swing Spout Faucet Made of chrome plated brass. Has a 9" spread swinging spout with anti-splash outlet. Valves are disc type with renewable internal assemblies. Faucet body is complete with an 1 $\frac{3}{16}$ " integral threaded mounting shank and a flanged locknut. Furnished with $\frac{3}{8}$ " flexible copper tubing water inlets.

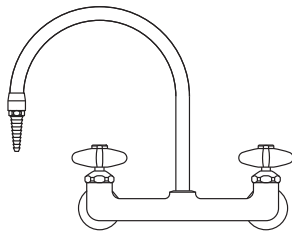

W-0354-00 Curb Mounted Hot and Cold Water Mixing Gooseneck Faucet Made of chrome plated brass. Has an 8" spread rigid gooseneck with removable straight serrated hose connector. Valves are disc type with renewable internal assemblies. Flanged inlets are complete with $\frac{3}{8}$ " I.P.S. tank nipples, locknuts and washers on 8" centers.

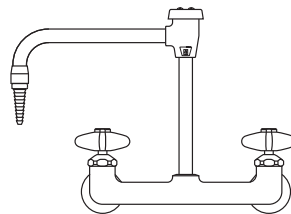

W-0354-0V Curb Mounted Hot and Cold Water Mixing Vacuum Breaker Gooseneck Faucet Same as No. W-0354-00 except supplied with vacuum breaker type gooseneck.

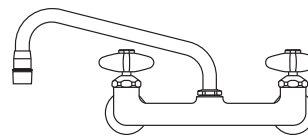

W-0355-00 Curb Mounted Hot and Cold Water Mixing Swing Spout Faucet Made of chrome plated brass. Has a 9" spread swinging spout with anti-splash outlet. Valves are disc type with renewable internal assemblies. Flanged inlets are complete with $\frac{3}{8}$ " I.P.S. tank nipples, locknuts and washers on 8" centers.

Laboratory Service Fittings

Mixing Faucet

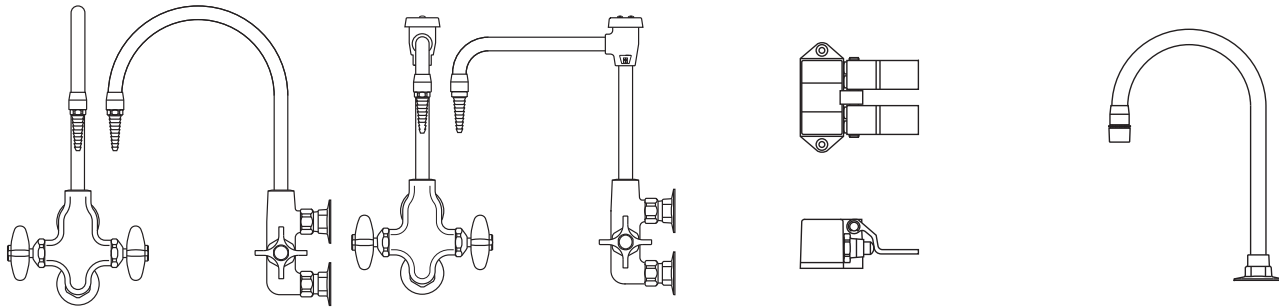

W-0361-00 Panel Mounted Hot and Cold Water Mixing Gooseneck Faucet

Chrome plated brass. Designed for mounting on fascia type reagent rack plumbing box uprights. It has an 8" spread rigid gooseneck equipped with a removable straight serrated hose connector. Valves are disc type with renewable internal assemblies. Flanged inlets on 3" centers are complete with 3/8" I.P.S. tank nipples, locknuts and washers.

W-0361-0V Panel Mounted Hot and Cold Water Mixing Vacuum Breaker Gooseneck Faucet

Same as W-0361-00 except supplied with vacuum breaker type gooseneck.

W-0825-00 Floor Mounted Foot Control Double Pedal Mixing Valve

is chrome plated brass. Has twin pedals with self-closing valves for mixing hot and cold water. 1/2" I.P.S. female thread inlets and outlet at the rear. Inlets are on 2" centers, 7/8" above floor. Outlet is on center 1 1/2" above floor.

W-0833-00 Deck Mounted Water Gooseneck Fitting

is chrome plated brass. Consisting of a 8" gooseneck with mounting flange and W-0532-00 aerator. 3/8" I.P.S. female thread inlet complete with tank nipple, locknut and washer. **Intended for use as an outlet for W-0825-00.**

Faucet Accessories/Options

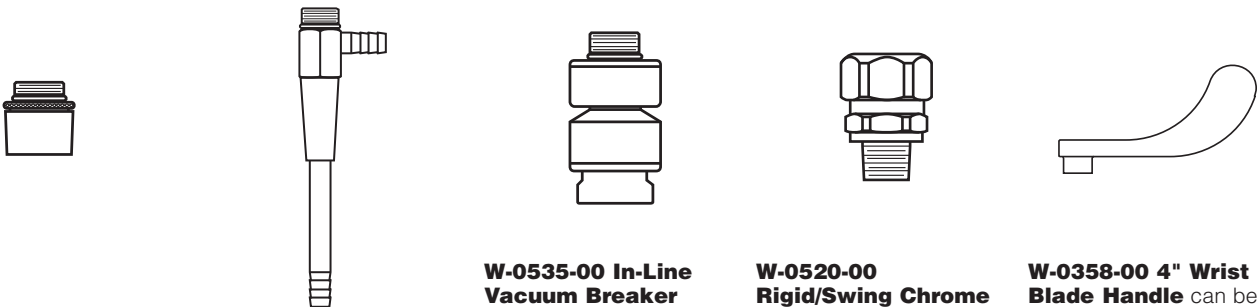

W-0532-00 Aerator

Anti-splash aerator can be used in lieu of the removable straight serrated hose connectors supplied with the gooseneck water faucet. 3/8" I.P.S. male thread inlet.

W-0510-00 Filter Pump (Aspirator)

5 1/2" high overall. Has serrated hose connector side and bottom outlets. 3/8" I.P.S. male thread inlet.

W-0535-00 In-Line Vacuum Breaker

Chrome plated. Mounts between the outlet end of a fitting (gooseneck, flange, etc.) and a removable serrated hose connector. 3/8" I.P.S. male thread inlet and female thread outlet. (Check plumbing codes for required location of vacuum breakers before ordering.)

W-0520-00 Rigid/Swing Chrome Plated Gooseneck Coupling

Designed for use with all standard goosenecks. Provides swinging gooseneck where desired. Remove washer for fixed installation. 3/8" I.P.S. male thread.

W-0358-00 4" Wrist Blade Handle

can be supplied for water faucet in lieu of four-armed or lever handles when specified. The 4" long handle is chrome plated.

Laboratory Service Fittings

Distilled Water Faucet

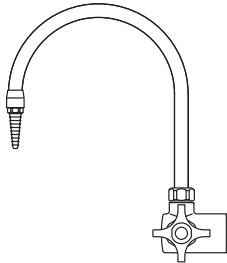

W-0367-00 Right Hand Distilled Water (Curb or Panel Mounted) Faucet

Chrome plated with a hot tin lined interior. It has a self-closing handle and a disc type valve with a renewable internal assembly. The 8" spread rigid gooseneck has a removable serrated hose end. 1/2" I.P.S. flanged female thread inlet complete with tank nipple, locknut and washer.

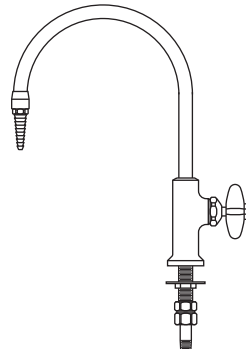

W-0368-00 Deck Mounted Distilled Water Gooseneck Faucet

Made of chrome plated brass. Has a hot tin lined interior. It has a self-closing handle and a disc type valve with renewable internal assembly. The 8" spread rigid gooseneck has a removable serrated hose end. Faucet is complete with a 3/8" I.P.S. tank nipple, flanged locknut, 3/8" I.P.S. male thread inlet with coupling nut and 1/4" I.P.S. tailpiece.

Ultra-Pure Deionized Water Faucet

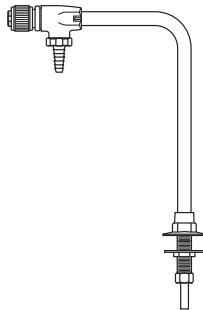

W-0407-00 Distilled, Deionized and Ultra-Pure Water Faucet (deck mounted)

made of chrome plated brass. All polypropylene internal construction with 6" spread gooseneck. Furnished with 1/2" I.P.S. shank with locknut and washer. Inlet is 3/8" O.D. compression.

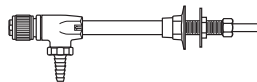

W-0408-00 Distilled, Deionized and Ultra-Pure Water Faucet (panel mounted)

made of chrome plated brass. All polypropylene internal construction with 6" spread gooseneck. Furnished with 1/2" I.P.S. shank with locknut and washer. Inlet is 3/8" O.D. compression.

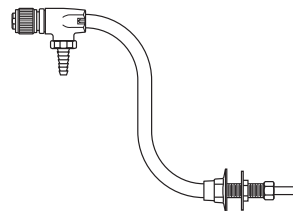

W-0409-00 Distilled Deionized and Ultra-Pure Water Faucet (panel mounted)

made of chrome plated brass. All polypropylene internal construction with 8" spread gooseneck. Furnished with 1/2" I.P.S. shank with locknut and washer. Inlet is 3/8" O.D. compression.

Laboratory Service Fittings

Vandal-Resistant Fittings

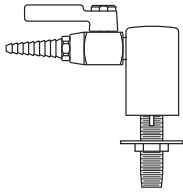

W-0410-VR Vandal Resistant Deck Mounted Gas, Air or Vacuum Fitting with single vandal-resistant laboratory ball valve. Complete with a $\frac{3}{8}$ " I.P.S. tank nipple, locknut and washer. **Specify service desired.**

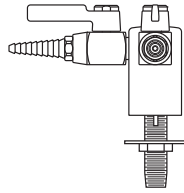

W-0411-VR Vandal Resistant Deck Mounted Double Gas, Air or Vacuum Fitting with two vandal resistant laboratory ball valves with integral straight serrated hose ends at 90°. Complete with a $\frac{3}{8}$ " I.P.S. tank nipple, locknut and washer. **Specify service desired.**

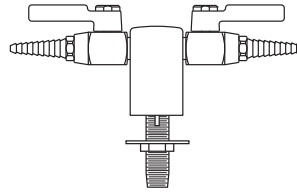

W-0412-VR Vandal Resistant Deck Mounted Double Gas, Air or Vacuum Fitting Same as W-0411-VR except at 180°. Complete with a $\frac{3}{8}$ " I.P.S. tank nipple, locknut and washer. **Specify service desired.**

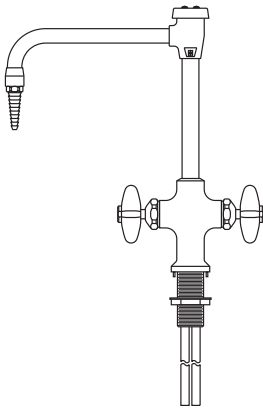

W-0413-VR Vandal Resistant Deck Mounted Hot and Cold Mixing Faucet with 8" rigid vacuum breaker gooseneck. Valves are disc type with renewable internal assemblies. Faucet body is complete with an integral threaded mounting shank and a flanged locknut. $\frac{1}{2}$ " I.P.S. male thread inlets with coupling nuts for slip joint connections.

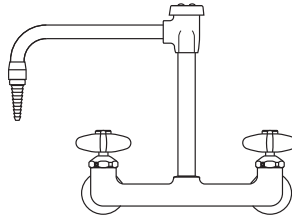

W-0414-VR Vandal Resistant Panel Mounted Hot and Cold Mixing Faucet with 8" rigid vacuum breaker gooseneck and mounting shanks.

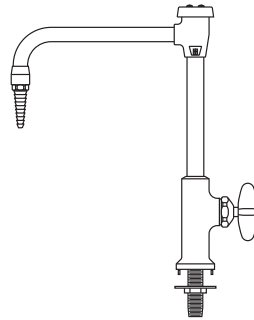

W-0415-VR Vandal Resistant Deck Mounted Water Faucet with 8" rigid vacuum breaker gooseneck.

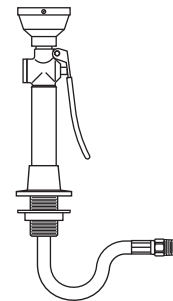

W-0417-VR Vandal Resistant Deck Mounted Hand-Held Drench Hose with single spray type outlet heads, squeeze-lever operated valve and flexible stainless steel hose. $\frac{3}{8}$ " I.P.S. male inlet.

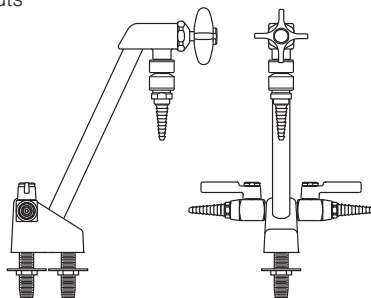

W-0416-VB Vandal Resistant Deck Mounted Combination Vacuum Breaker Water/Gas Fitting Made of chrome plated base. Rigid gooseneck with disc type valve and in-line vacuum breaker. Includes two-way turret with two laboratory ball valves. Complete with two $\frac{3}{8}$ " I.P.S. tank nipples, locknuts and washers. **Specify service desired.**

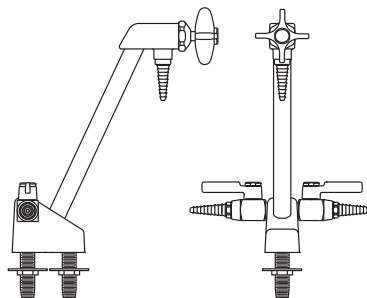

W-0416-VR Vandal Resistant Deck Mounted Combination Water/Gas Fitting Same as W-416-VB except furnished without in-line vacuum breakers. **Specify service desired.**

Laboratory Service Fittings

Emergency Eye Wash/Shower Equipment

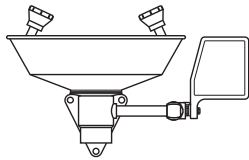

W-0927-00 Panel Mounted Eye Wash Fixture Consists of stainless steel bowl, two Gentle Spray outlet heads, a "PUSH TO OPERATE" ball valve and mounting bracket. 1/2" I.P.S. female thread inlet and 1 1/4" I.P.S. female thread outlet.

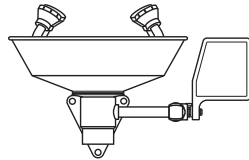

W-0933-00 Eye/Face Wash (wall mounted) the same as No. W-0927-00, except with four Gentle Spray outlet heads for complete coverage of eyes and face.

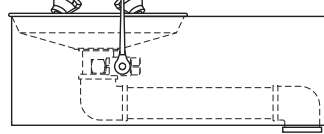

W-0930-00 BARRIER-FREE (ADA) Eye/Face Wash (wall mounted) with four Gentle Spray outlet heads, stainless steel skirt and bowl and stay-open ball valve. 1/2" I.P.S. female thread inlet and 1 1/4" I.P.S. female thread outlet.

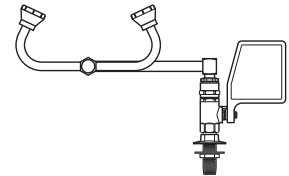

W-0931-00 Eye Wash (deck mounted) with two Gentle Spray outlet heads, stay-open ball valve and 90° swivel feature (right hand mounting).

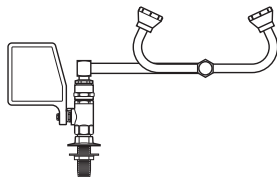

W-0932-00 Eye Wash (deck mounted) the same as No. W-0931-00 but (left hand mounting).

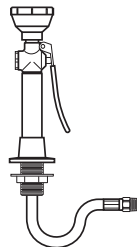

W-0923-00 Deck Mounted Hose Spray Fitting Consists of 8 ft. reinforced PVC hose with a squeeze-lever operated valve and spray-type outlet head with a protective rubber collar. Flange, shank and locknut for attaching to table top are included. 3/8" I.P.S. male thread swivel inlet.

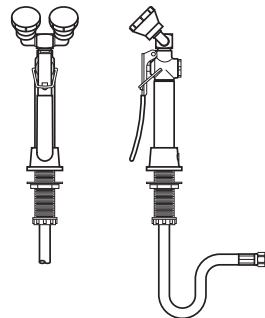

W-0934-00 Deck Mounted Dual Purpose Eye Wash/Drench Hose with two Gentle Spray outlet heads angled at 45° and squeeze valve with locking clip. Flange, shank and locknut for attaching to table top are included. 3/8" I.P.S. male thread swivel inlet.

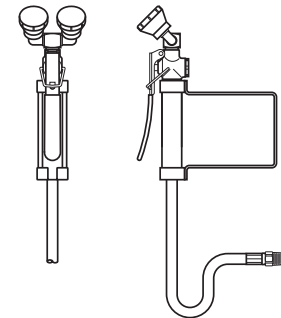

W-0935-00 Wall Mounted Dual Purpose Eye Wash/Drench Hose the same as No. W-0934-00 except wall mounted.

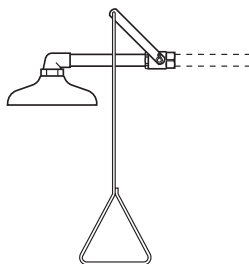

W-0374-01 Emergency Shower Head Assembly (horizontally mounted). Includes 10" diameter orange ABS plastic shower head. Operated by a rigid pull-rod and easy to grip handle. Complete with an elbow, connecting pipe and ball valve. 1" I.P.S. female thread inlet.

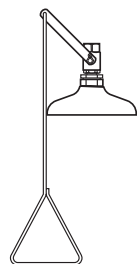

W-0928-01 Emergency Shower Head Assembly (vertically mounted). The same as No. W-0374-01 except vertically mounted.

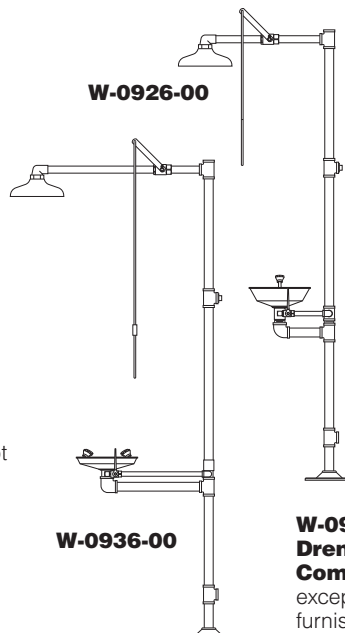

W-0926-00 Drench Shower and Eye Wash Combination A necessity for chemical stockrooms and other areas handling a quantity of corrosive chemicals. Free-standing 10" dia. drench shower made of orange ABS plastic. Has a 1" ball valve operated by a rigid pull-rod and easy to grip handle. Eye wash fixture with stainless steel bowl, two Gentle Spray heads and a "PUSH TO OPERATE" ball valve. Eye wash and shower operate independently. Overall height is 7'6". 1 1/4" I.P.S. female thread inlet and outlet.

W-0936-00 BARRIER-FREE (ADA) Drench Shower and Eye Wash Combination Similar to No. W-0926-00 except this unit is barrier-free and eye wash furnished with four Gentle Spray heads.