

Suspended Base Cabinets – 19" High

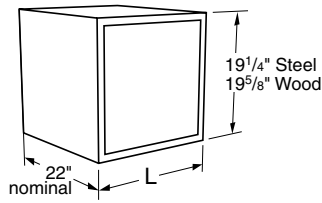

Specifications:

Suspended Base Cabinets are designed to hang beneath 28" deep Worksurface or Table Frames. They are available in either steel or wood construction and require a Cabinet Hanging Rail Kit (see page 13) be added to the frame for attachment.

Cabinets on this page are a nominal 19" high, and are available in lengths shown.

See page 24 for designating cabinet style, door and drawer head material, and hardware selection.

Cupboard Base Cabinets

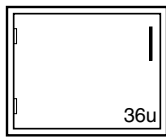

Steel Cabinet	Length	Wood Cabinet
C03M192215L -----	15"	C03W202215L -----
C03M192218L -----	18"	C03W202218L -----
C03M192221L -----	21"	C03W202221L -----
C03M192224L -----	24"	C03W202224L -----

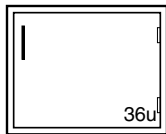
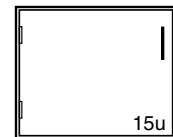

Steel Cabinet	Length	Wood Cabinet
C03M192215- -----	15"	C03W202215- -----
C03M192218- -----	18"	C03W202218- -----
C03M192221- -----	21"	C03W202221- -----
C03M192224- -----	24"	C03W202224- -----



Drawer Base Cabinets

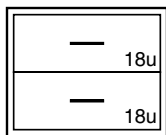

Steel Cabinet	Length	Wood Cabinet
D00M192215- -----	30"	D00W202215- 0 -----
D00M192218- -----	36"	D00W202218- 0 -----
D00M192221- -----	42"	D00W202221- 0 -----
D00M192224- -----	48"	D00W202224- 0 -----

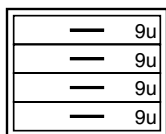
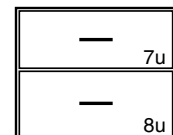

Steel Cabinet	Length	Wood Cabinet
D30M192215- -----	15"	D30W202215- 0 -----
D30M192218- -----	18"	D30W202218- 0 -----
D30M192221- -----	21"	D30W202221- 0 -----
D30M192224- -----	24"	D30W202224- 0 -----

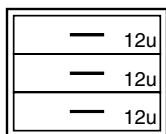
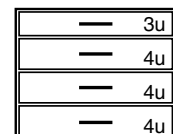

Steel Cabinet	Length	Wood Cabinet
D50M192215- -----	15"	D50W202215- 0 -----
D50M192218- -----	18"	D50W202218- 0 -----
D50M192221- -----	21"	D50W202221- 0 -----
D50M192224- -----	24"	D50W202224- 0 -----

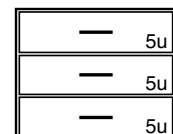

Suspended Base Cabinets – 19" High

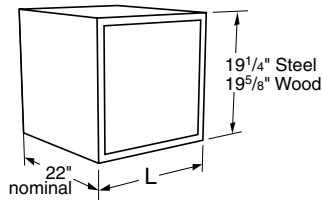

Specifications:

Suspended Base Cabinets are designed to hang beneath 28" deep Worksurface or Table Frames. They are available in either steel or wood construction and require a Cabinet Hanging Rail Kit (see page 13) be added to the frame for attachment.

Cabinets on this page are a nominal 19" high, and are available in lengths shown.

See page 24 for designating cabinet style, door and drawer head material, and hardware selection.

Drawer Base Cabinets

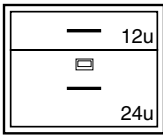

1 File Drawer with hangers

Steel Cabinet	Length	Wood Cabinet
D81M192215- -----	15"	D81W202215- 0 ---
D81M192218- -----	18"	D81W202218- 0 ---
D81M192221- -----	21"	D81W202221- 0 ---
D81M192224- -----	24"	D81W202224- 0 ---

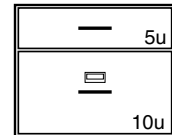

1 File Drawer with hangers

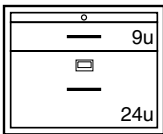

Steel Cabinet	Length	Wood Cabinet
D85M192215- -----	15"	D85W202215- 0 ---
D85M192218- -----	18"	D85W202218- 0 ---
D85M192221- -----	21"	D85W202221- 0 ---
D85M192224- -----	24"	D85W202224- 0 ---

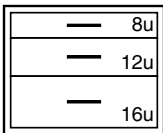
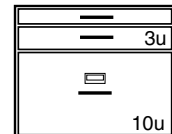

Steel Cabinet	Length	Wood Cabinet
D86M192215- -----	15"	D86W202215- 0 ---
D86M192218- -----	18"	D86W202218- 0 ---
D86M192221- -----	21"	D86W202221- 0 ---
D86M192224- -----	24"	D86W202224- 0 ---

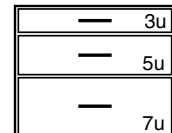

Suspended Base Cabinets – 25" High

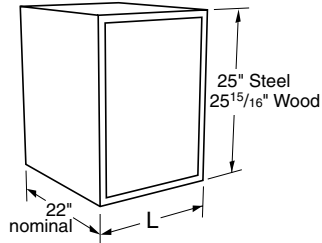

Specifications:

Suspended Base Cabinets are designed to hang beneath 28" deep Worksurface or Table Frames. They are available in either steel or wood construction and require a Cabinet Hanging Rail Kit (see page 13) be added to the frame for attachment.

Cabinets on this page are a nominal 25" high, and are available in lengths shown.

See page 24 for designating cabinet style, door and drawer head material, and hardware selection.

Cupboard Base Cabinets

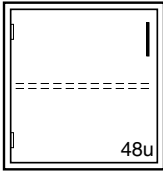

Steel Cabinet	Length	Wood Cabinet
C03M252215L -----	15"	C03W262215L_0 ---
C03M252218L -----	18"	C03W262218L_0 ---
C03M252221L -----	21"	C03W262221L_0 ---
C03M252224L -----	24"	C03W262224L_0 ---

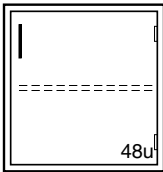
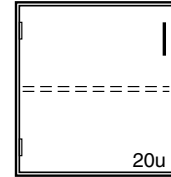

Steel Cabinet	Length	Wood Cabinet
C03M252215- -----	15"	C03W262215-_0 ---
C03M252218- -----	18"	C03W262218-_0 ---
C03M252221- -----	21"	C03W262221-_0 ---
C03M252224- -----	24"	C03W262224-_0 ---

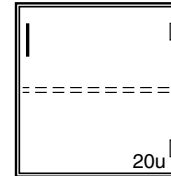

Drawer Base Cabinets

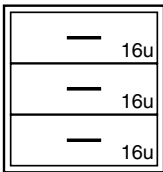

Steel Cabinet	Length	Wood Cabinet
D00M252215- -----	15"	D00W262215-_0 ---
D00M252218- -----	18"	D00W262218-_0 ---
D00M252221- -----	21"	D00W262221-_0 ---
D00M252224- -----	24"	D00W262224-_0 ---

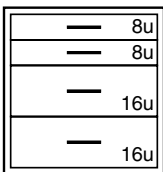
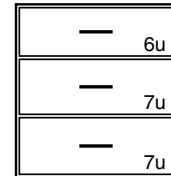

Steel Cabinet	Length	Wood Cabinet
D08M252215- -----	15"	D08W262215-_0 ---
D08M252218- -----	18"	D08W262218-_0 ---
D08M252221- -----	21"	D08W262221-_0 ---
D08M252224- -----	24"	D08W262224-_0 ---

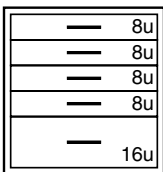
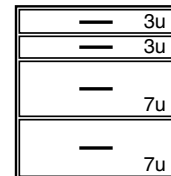

Steel Cabinet	Length	Wood Cabinet
D10M252215- -----	15"	D10W262215-_0 ---
D10M252218- -----	18"	D10W262218-_0 ---
D10M252221- -----	21"	D10W262221-_0 ---
D10M252224- -----	24"	D10W262224-_0 ---

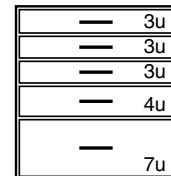

Suspended Base Cabinets – 25" High

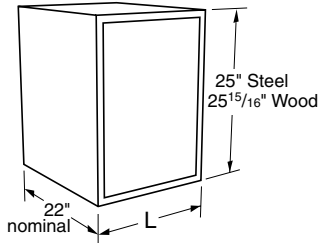

Specifications:

Suspended Base Cabinets are designed to hang beneath 28" deep Worksurface or Table Frames. They are available in either steel or wood construction and require a Cabinet Hanging Rail Kit (see page 13) be added to the frame for attachment.

Cabinets on this page are a nominal 25" high, and are available in lengths shown.

See page 24 for designating cabinet style, door and drawer head material, and hardware selection.

Drawer Base Cabinets

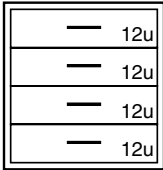

Steel Cabinet	Length	Wood Cabinet
D30M252215- _____	15"	D30W262215- 0 _____
D30M252218- _____	18"	D30W262218- 0 _____
D30M252221- _____	21"	D30W262221- 0 _____
D30M252224- _____	24"	D30W262224- 0 _____

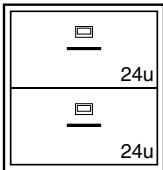
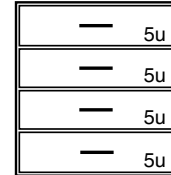

Steel Cabinet	Length	Wood Cabinet
D81M252215L _____	15"	D81W262215- 0 _____
D81M252218L _____	18"	D81W262218- 0 _____
D81M252221L _____	21"	D81W262221- 0 _____
D81M252224L _____	24"	D81W262224- 0 _____

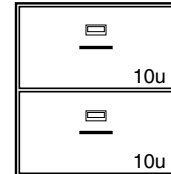

2 File Drawers with hangers

2 File Drawers with hangers

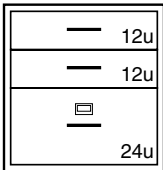

Steel Cabinet	Length	Wood Cabinet
D85M252215- _____	15"	D85W262215- 0 _____
D85M252218- _____	18"	D85W262218- 0 _____
D85M252221- _____	21"	D85W262221- 0 _____
D85M252224- _____	24"	D85W262224- 0 _____

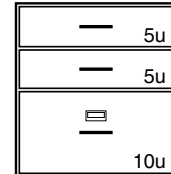

1 File Drawer with hangers

1 File Drawer with hangers

Drawer & Cupboard Base Cabinets

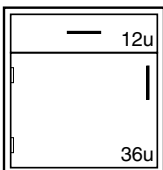

Steel Cabinet	Length	Wood Cabinet
E40M252215L _____	15"	E40W262215L _____
E40M252218L _____	18"	E40W262218L _____
E40M252221L _____	21"	E40W262221L _____
E40M252224L _____	24"	E40W262224L _____

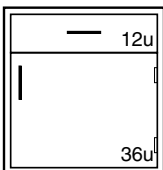
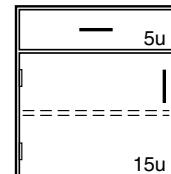

Steel Cabinet	Length	Wood Cabinet
E40M252215- _____	15"	E40W262215- _____
E40M252218- _____	18"	E40W262218- _____
E40M252221- _____	21"	E40W262221- _____
E40M252224- _____	24"	E40W262224- _____

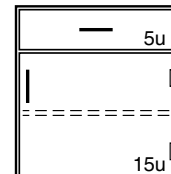

Upper Storage Cabinets

Upper Cabinet Hanging System

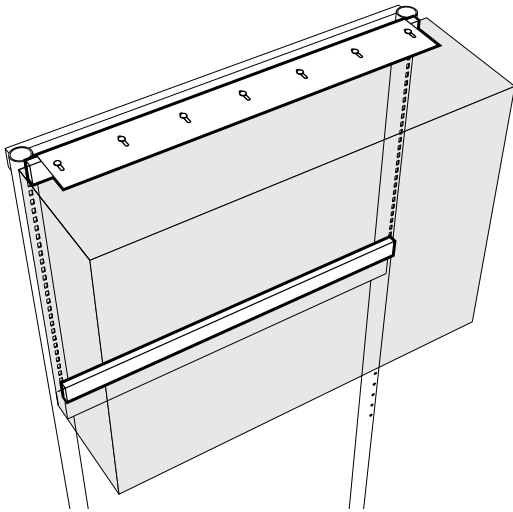

With the use of an Upper Hanging Bracket and a pair of Hanging Rails, Kewaunee's standard Wall Cabinets can be mounted on the Enterprise Workstation Support Frame. Two Hanging Rails are snapped into the Support Frame slots. The Upper Hanging Bracket bolts to the top of the upper cabinet which then hangs on the upper Hanging Rail. The lower Hanging Rail allows the bottom of the cabinet to be securely fastened to the module.

Hanging Rails and Upper Hanging Brackets, are finished to match the Workstation Support Frame and are furnished with all required hardware.

Hanging Rails are furnished in pairs.

Order the Upper Hanging Bracket in the same length as the Upper Cabinet. The Hanging Rails must be the same length as the Workstation Support Frame.

Recommended for use with Double-sided Support Frames, and Single-sided Support Frames installed against a wall.

Upper Hanging Bracket

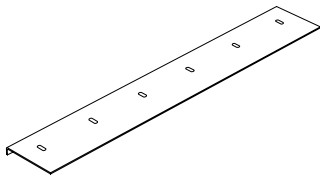

Length	Part Number
18"	FE48M010418-00
24"	FE48M010424-00
30"	FE48M010430-00
36"	FE48M010436-00
42"	FE48M010442-00
48"	FE48M010448-00

Hanging Rails

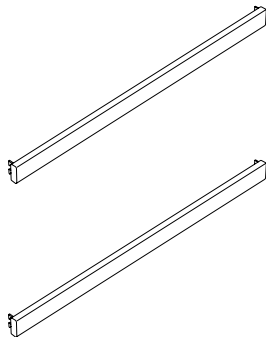

Length	Part Number	
29"	FE49M020129-00	1 pair
35"	FE49M020135-00	1 pair
47"	FE49M020147-00	1 pair
40"	FE49M020140-00	1 pair
46"	FE49M020146-00	1 pair

Sliding Plate Glass Door Cabinets

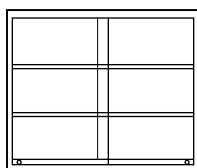

Depth	Steel Cabinet	Length	Wood Cabinet	Depth
12 ³ / ₄ "	W10M301330-0000	30"	W10W301230-00_0	12"
12 ³ / ₄ "	W10M301336-0000	36"	W10W301236-00_0	12"
12 ³ / ₄ "	W10M301342-0000	42"	W10W301242-00_0	12"
12 ³ / ₄ "	W10M301348-0000	48"	W10W301248-00_0	12"
16"	W10M301630-0000	30"	W10W301630-00_0	16"
16"	W10M301636-0000	36"	W10W301636-00_0	16"
16"	W10M301642-0000	42"	W10W301642-00_0	16"
16"	W10M301648-0000	48"	W10W301648-00_0	16"

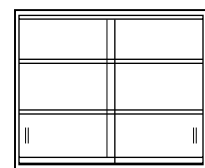

Upper Cabinets – 30" High

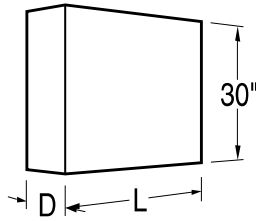

Specifications:

These Upper Cabinets are 30" high and available in two depths. Lengths as shown. They are provided with two adjustable shelves, and are available in either wood or steel.

Hanging system must be ordered separately.

Sliding Glazed and Panel Doors are suspended by roller from a track at the top of the cabinet.

See page 24 for designating cabinet door style, door and cabinet material, and pull and hinge selection.

Sliding Panel Door Cabinets

	Depth	Steel Cabinet	Length	Wood Cabinet	Depth
	12 ³ / ₄ "	W12M301330-___0	15"	W12W301230-00_0	12"
	12 ³ / ₄ "	W12M301336-___0	18"	W12W301236-00_0	12"
	12 ³ / ₄ "	W12M301342-___0	21"	W12W301242-00_0	12"
	12 ³ / ₄ "	W12M301348-___0	24"	W12W301248-00_0	12"
	16"	W12M301630-___0	15"	W12W301630-00_0	16"
	16"	W12M301636-___0	18"	W12W301636-00_0	16"
	16"	W12M301642-___0	21"	W12W301642-00_0	16"
	16"	W12M301648-___0	24"	W12W301648-00_0	16"

Swinging Glazed Door Cabinets

	Depth	Steel Cabinet	Length	Wood Cabinet	Nominal Depth
	12 ³ / ₄ "	W20M301318L	18"	W20W301218L	12 ³ / ₄ "
	12 ³ / ₄ "	W20M301324L	24"	W20W301224L	12 ³ / ₄ "
	16"	W20M301618L	18"	W20W301618L	16 ³ / ₄ "
	16"	W20M301624L	24"	W20W301624L	16 ³ / ₄ "

	Depth	Steel Cabinet	Length	Wood Cabinet	Nominal Depth
	12 ³ / ₄ "	W20M301318-	18"	W20W301218-	12 ³ / ₄ "
	12 ³ / ₄ "	W20M301324-	24"	W20W301224-	12 ³ / ₄ "
	16"	W20M301618-	18"	W20W301618-	16 ³ / ₄ "
	16"	W20M301624-	24"	W20W301624-	16 ³ / ₄ "

	Depth	Steel Cabinet	Length	Wood Cabinet	Nominal Depth
	12 ³ / ₄ "	W20M301330-___	30"	W20W301230-___	12 ³ / ₄ "
	12 ³ / ₄ "	W20M301336-___	36"	W20W301236-___	12 ³ / ₄ "
	12 ³ / ₄ "	W20M301342-___	42"	W20W301242-___	12 ³ / ₄ "
	12 ³ / ₄ "	W20M301348-___	48"	W20W301248-___	12 ³ / ₄ "
	16"	W20M301630-___	30"	W20W301630-___	16 ³ / ₄ "
	16"	W20M301636-___	36"	W20W301636-___	16 ³ / ₄ "
	16"	W20M301642-___	42"	W20W301642-___	16 ³ / ₄ "
	16"	W20M301648-___	48"	W20W301648-___	16 ³ / ₄ "